



Kinheim



WORKBOOK
Spring/Summer 2023

PASSION • MEMORIES • SOCIAL • BALANCE
 TOGETHER • SMILE • QUIET • SUNSET • FREEDOM
 COOKING • ADVENTURE • IMMERSION • FRIENDS • HYGGE®
 EXPLORE • EARTH • SIMPLICITY • SWIMMING • MAGICAL
 MOMENTS • DIGITAL DETOX • WIND • NATURE • COFFEE
 TRAVEL • LIFE • MOMENTS • LAUGHTER • CAMP
 RELAX • FRESH • CAMPFIRE



CONTENT

The Spirit of Nordisk	3	Sleeping bag features.....	146
Designed by Nordisk.....	5	Season description.....	147
Dedicated to our Planet.....	6	Construction details.....	148
What's your passion?.....	8	Sleeping bag shape, zipper, size.....	149
Spirit	10	Tent fabrics.....	150
Ambition	80	Product overviews	
Addiction	112	Tents.....	152
The 2 kg camp.....	130	Tarps.....	164
Home of the down specialist.....	132	Sleeping bags.....	166
Sleeping bag academy		Mats.....	174
Down vs. Fibre.....	140	Retail Accessories.....	176
Filling.....	142	Spareparts.....	179
		Nordisk International.....	182

DISCLAIMER
 General deviations for data, such as weight and dimensions/volume can be up to 5%.
 Nordisk Company A/S makes reservations for typing errors, minor alterations to product specifications or cancelling products.

IMAGES ©
 Mikkel Heftø
 Thomas Peters
 Uwe Hauth
 Mikkel Beisner
 Reiziger.co
 Jeppe Kuld
 Deux Pas Vers L'Autre
 Kollektiveproductions
 Honza Zak
 Lars Bukkehave
 Martin Paldan
 Startrails
 Triggerlust-some

The Spirit of Nordisk

We have always considered Nordisk to be synonymous with **Hygge®**.
 We love bonfire conversations and how a sudden smell of smoke can always revive the laughs and stories that were once shared in a great camp.

Nature has moved much more into everybody's minds and has become the natural or digital backdrop of more meetings, conversations and gatherings than ever before. In Denmark, as in many other parts of the world, we see nursery homes, kindergartens, schools and even companies moving outside. And I'm sure this will have lasting effects on everybody.

In fact, science has now documented how being active and staying outside not only improves your perception of quality in life, it literally improves your life! You'll live longer. Happier. With improved health, more energy and more stories to pass on.

So now is the time to get outdoor and change our lives for the better. We want to inspire everyone to get a taste of nature, to make it accessible and manageable and to let the smell of bonfire smoke spread into our everyday lives, to put a smile on our faces and images in our heads. Whenever you imagine a camp, an outdoor moment, a fire and a smile - Nordisk should be right there with you. In spirit.

And to put action behind our words of being a source of inspiration, visiting Nordisk will no longer be like visiting an office. We are rethinking the entire idea of a brand headquarter and will inaugurate our new basecamp before this collection hits the shops. When you come to visit, you will witness an inspiring working campsite in Silkeborg, the Outdoor Capital of Denmark, and right next to nature.

Let's go outside - and see you out there!

Erik J. Møller

Owner & CEO (Chief Executive Outdoorer)





Designed by Nordisk

**At Nordisk we place great emphasis on design.
The goal is to make a real difference for you.
For the adventurer.**

To us, great design means that products need to do more than just look good. They need to feel good, be innovative, have a clear purpose and a high degree of functionality to serve that purpose. And finally, to be made with respect for nature. All very traditional Danish design values that are deeply rooted and respected within the whole Nordisk organization and reflected in any product bearing our iconic polar bear logo.

And most importantly; a quality product will prove to be a reliable friend for years. Making sure that our products will last, is the best way to reduce mass consumption, thus ensuring an eternal playground for adventure.

That extraordinary magical feeling of freedom, you can only experience in Nature.

Go EXPLORE. Go NORDISK.



Dedicated to our Planet

We consider Nordisk to be part of a simple ecosystem where nature is an integral part of our design process, and for that, we thank nature by acting responsibly.

Not *just* by funding an NGO.

Not *just* by removing PVC from packaging.

Not *just* by acquiring an industry standard certificate.

And not *just* by a lonesome marketing project.

For decades, Nordisk has invested in responsible production, developed internal sustainability standards that exceed industry certificates and invested in innovative materials to benefit the future of the nature we hold so dear. And we keep exploring new ways to do good while delivering quality gear that lasts a lifetime.



A responsible Partner

Nordisk is part of The Business Social Compliance Initiative, the leading business-driven initiative for companies committed to improving working conditions in the global supply chain.

We fight for the Global Goals

In 2015, world leaders agreed to 17 goals for a better world by 2030. These goals have the power to end poverty, fight inequality and stop climate change. We are excited to have joined the project where Nordisk and the UN now work closely together to reach the Global Goals for Sustainable Development.

NORDISK®
ORGANIC COTTON

HANDMADE IN GERMANY

We are very proud of our production and service facility in Görlitz where we build our down sleeping bags by hand and have done so for more than 35 years.



THE GLOBAL GOALS

DON'T POISON YOURSELF!

At Nordisk, we are working actively to reduce and eliminate the chemicals used in products and production processes. And we strive to ensure that the materials and chemicals needed, are as eco-friendly and non-harmful as possible. This goes through the entire production process, from preparation of raw materials, through the actual production (and the people engaged in it) to how the product is delivered to the end consumer.



SUSTAINABILITY BEGINS WITH PRODUCTS THAT LAST!



Certified responsible

Apart from our own strict Ethical Down Code, we obviously comply with international regulations set forth by the European Down & Feather Association and the Responsible Down Standard.

DON'T WORRY - we can fix it

Having our own manufacturing facility in Germany allows us to offer a fast and reliable repair service, ensuring your product a longer lifespan and giving new life to damaged products.

Ethical Down Code

Animal welfare, reliable traceability and exceptional quality have always been our priority when choosing our insulation fillings. So we invented our own strict down policy years before international standards were introduced, and to this day, our own Ethical Down Code is still a better protection of both animals and planet than standard certificates and legislation, such as RDS and EDFA. Every single piece of Crystal Down is traceable, washable and European. Read more on www.thedownspecialist.com.



RECYCLING FOR A BRIGHTER FUTURE

By turning used plastic bottles and fishnet into new fabrics and fibre fillings, we help remove harmful materials from nature.

A PATH UNVEILED: NYLON CAN BE GROWN

In 2014, in collaboration with Toray Inc, we developed the world's first eco-friendly down jacket. Extracting plant oil from the Ricinus plant, we have made it possible to create sustainable nylon fibres, replacing the need for crude oil that would take nature hundreds of thousands of years to form, and even longer to recover from.

NEXT TO NATURE

100% PFC FREE IS OUR GOAL

PFCs (Per-fluorinated compounds) are generally part of DWR (Durable Water Repellent) treatments due to their superior water and oil repellency. PFCs are harmful to the environment, and Nordisk is constantly working on removing all PFCs from our apparel - and we are getting closer and closer to our goal.

What's your passion?

We know that all kinds of people make great use of our products every day. People for whom the feeling of exceptional quality serves very different purposes; from luxury glamping to ultralightweight expeditions.

Finding new gear should be fun, inspiring and relevant.
So we made it easy for you.

Which is your Nordisk universe?

**SPI
RIT**



Conscious
Happiness
Legacy
Recharge
Enjoy
Together
Hygge

**AMBI
TION**



Dreams
Explore
Purpose
Dare
Aching
Moments
Memories

**AD
DIC
TION**



Pain
Hunger
Thrill
Pulse
Force
No compromise
Expedition



**SPI
RIT**



DO WHAT YOU LOVE.
LOVE WHAT YOU DO.
TIME IS LIMITED.
GRAB IT, TAKE CONTROL
AND LIVE FREELY.
GO OUT. RECHARGE.

YOUR SPIRIT. OUR PASSION.

**SPI
RIT**

Conscious
Happiness
Legacy
Recharge
Enjoy
Together
Hygge®



SPIRIT

Midgard Concept.....14
 Midgard 18
 Vimur 21
 Midgard Connector, Annex 22

Tents
 There is only one original!..... 25
 Alfheim, Dromi Flagline 27
 Asgard Denim, Asgard 7.1/12.6/19.6,..... 28
 Ydun Sky, Utgard sky 31
 Let the sun shine in 32
 Vanaheim 34
 Reisa, Thrymheim 36

Colour My Adventure38
 Kari Mini..... 40
 Ydun Tech Mini, Asgard Tech Mini 41
 Ygg, Yggdrasil 42
 Accessories 43

Tarps 44

Sleeping Bags & accessories
 Almond, Mos Down slippers, Mug, Bottle 48
 Puk..... 51
 Kiby, Hermod Down slippers, Voyage 52
 Tension..... 54
 Kids 56
 Cosy Feet, Cosy Legs, Cosy Cover 60

Mats & Pillows 62

Bags and Packs
 Kongsberg, Tote Bag, Karlstad 64
 Verran, Tinn, Halmstad, Ribe, Nibe..... 66

Furniture
 Marielund chair, Risskov table,
 Kongelund lounge chair 68
 Moesgaard, Marselis, Rold, Rebild 70
 Torden Wood Burner 72
 Madam Blå - Enamel Kitchenware..... 74
 Cutlery & Cookware 78



THE MIDGARD CONCEPT COTTON CASTLE



Imagine setting up your own holiday castle

Spending your holiday as kings and queens in nature without compromising on comfort and luxury. And leaving without a trace.

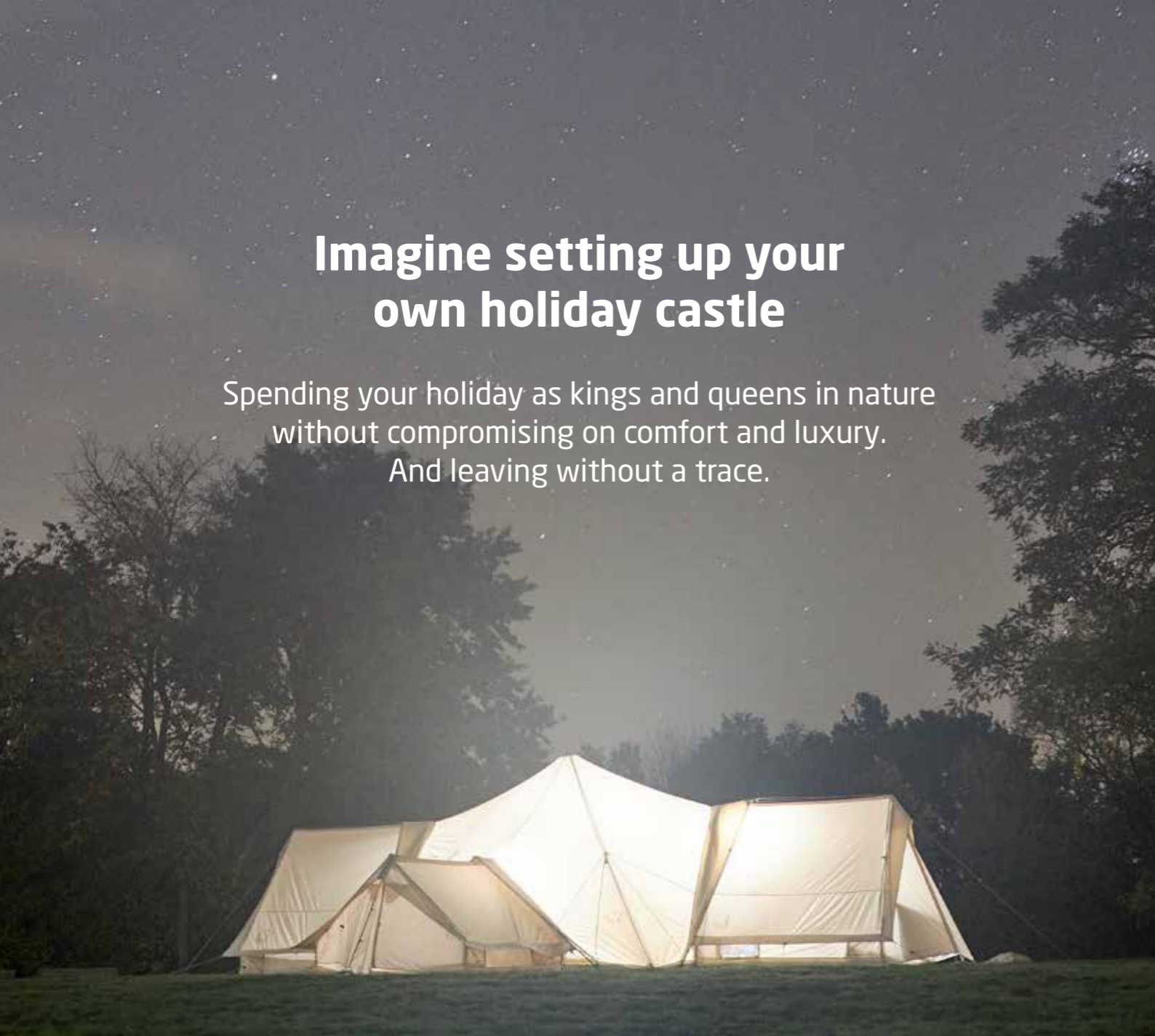

In Norse Mythology, humans lived in the realm of Midgard where a strong social bond was essential to a tribe's survival and well-being. The classic longhouses, and later the iconic stave churches, are examples of how the Vikings and their descendants designed their lives with a starting point in the community.

This has been the inspiration for creating The Midgard Concept; a completely new and more social way of sleeping outside. With a dedicated space for a community to gather and socialize and the opportunity to expand your castle with individual tents, you will experience outdoor living in ways you had never imagined.

Where are the poles?

That's right; when you are in the Midgard, the most amazing thing is actually what is not there! Gaining that amount of space and standing height (and then some!) without those annoying centre poles seem unbelievable. But the innovative Turtle Hub® construction has enabled us to create a huge space with no obstacles, so you can have the freedom of decorating your castle just the way you dream of.





Midgard makes your camp the centre of attention

With its majestic architecture, its welcoming gates and its spacious interior, sleeping outdoors has never been more glamorous.

Build your own cotton castle camp, suiting your needs for space and separate sleeping rooms.

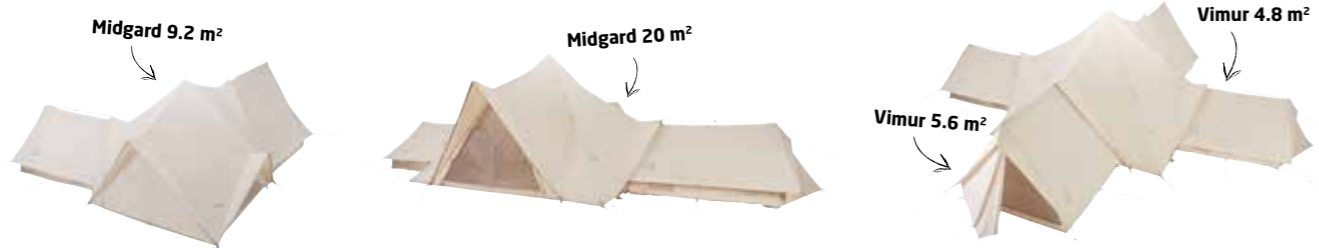

MIDGARD 9.2 M²

Cotton Castle Centrepiece

- 4 entrances that connect to any Midgard attachment
- Sewn-in bathtub floor
- 2.7 m central standing height
- A-frame structure with no centre pole and entrance poles
- Great ventilation and indoor climate
- Super easy set-up

Colour	Sandshell
Material flysheet	Technical Cotton 65% Polyester, 35% Cotton
Material groundsheet	100% waterproof Tarpaulin / sewn-in floor
Net weight	27.800 g
Pack size	Flysheet: 40 x 110 cm Poles: 20 x 70 cm
Item no.	142029

MIDGARD 20 M²

Cotton Castle Centrepiece

- 4 entrances that connect to any Midgard attachment
- Sewn-in bathtub floor
- 3.0 m central standing height
- A-frame structure with no centre pole and entrance poles
- Great ventilation and indoor climate
- Super easy set-up

Colour	Sandshell
Material flysheet	Technical Cotton 65% Polyester, 35% Cotton
Material groundsheet	100% waterproof Tarpaulin / sewn-in floor
Net weight	42.500 g
Pack size	Flysheet: 46 x 110 cm Poles: 35 x 70 cm
Item no.	142033

Midgard and Vimur - made for each other

Our Nordic ancestors believed that the River Vimur was the greatest of all rivers and had existed since the beginning of time. So it makes perfect sense to name an all time greatest classic ridge tent after this particular river. But as great as the Vimur is on its own - it is even greater in combination with the Midgard centre hall or expanded with a Midgard Annex. As all products in the Midgard Concept, the Vimur attaches perfectly to form an integrated expansion.

Impress anyone who passes by.



VIMUR 4.8 M²

An amazing cotton ridge tent to use on its own or connected to the Midgard.

- Great sleeping area or maybe a storage room to keep your castle nice and tidy
- Great ventilation and indoor climate
- Full opening in each end
- A-frame structure with no centre pole

	
Colour	Sandshell
Material flysheet	Technical Cotton 65% Polyester, 35% Cotton
Material groundsheet	100% waterproof Tarpaulin / sewn-in floor
Net weight	14.200 g
Pack size	Flysheet: 31 x 80 cm Poles: 20 x 61 cm
Item no.	142030



VIMUR 5.6 M²

Huge cotton ridge tent to use on its own or connected to the Midgard.

- Standing height makes this tent an incredibly spacious sleeping area
- Great ventilation and indoor climate
- Full opening in each end
- A-frame structure with no centre pole

	
Colour	Sandshell
Material flysheet	Technical Cotton 65% Polyester, 35% Cotton
Material groundsheet	100% waterproof Tarpaulin / sewn-in floor
Net weight	18.700 g
Pack size	Flysheet 36 x 84 cm Poles 11 x 58 cm
Item no.	142031



Midgard attachments

Expand your glamping realm!

Turn your castle into a kingdom!

With the Midgard Connector, you can now combine multiple Midgards into one construction, truly making the expansion possibilities endless. Build an entire village of halls and rooms with standing height connectors between them. Or simply connect two amazing tent halls into one.

With the Midgard Annex, you can add some extra storage or sleeping space to your Vimur or Midgard, allowing you to tuck away your bags, shoes and equipment. Use it as a sleeping cabin for overnight guests or maybe as a cozy little kids corner for a quiet moment with a great book or puzzle.



MIDGARD CONNECTOR

Midgard tunnel connector

- Hallway to fit the two door sides of any Midgard tent
- Standing height passage
- Zipper attachments in each end

Colour	Sandshell
Material flysheet	Technical Cotton, 65% Polyester, 35% Cotton
Material groundsheet	100% waterproof Tarpaulin / sewn-in floor
Net weight	5.000 g
Pack size	18 x 42 cm
Item no.	107269

VIMUR ZIP ADAPTER

Extends your Vimur tent with a Midgard Annex

- Easy to attach and to stow away when not needed
- Zipper band matching the counterparts on the Vimur backside and the matching Midgard Annex

	Small	Large
Colour	Sandshell	
Material flysheet	Technical Cotton, 65% Polyester, 35% Cotton	
Net weight	800 g	1.000 g
Pack size	14 x 27 cm	18 x 27 cm
Item no.	107272	107273



MIDGARD ANNEX SMALL

Small vestibule connection

- Connects to window sides of any Midgard tent
- Create extra space out of the blue when needed
- The perfect aesthetic ending to your castle

Colour	Sandshell
Material flysheet	Technical Cotton, 65% Polyester, 35% Cotton
Material groundsheet	100% waterproof Tarpaulin / sewn-in floor
Net weight	4.100 g
Pack size	17 x 41 cm
Item no.	107270



MIDGARD ANNEX LARGE

Large vestibule connection

- Connects to door sides of any Midgard tent
- Create extra space out of the blue when needed
- The perfect aesthetic ending to your castle

Colour	Sandshell
Material flysheet	Technical Cotton, 65% Polyester, 35% Cotton
Material groundsheet	100% waterproof Tarpaulin / sewn-in floor
Net weight	5.700 g
Pack size	20 x 44 cm
Item no.	107271

There is only one original!

It is no challenge finding look-alikes on the market. But what is it exactly that sets Nordisk apart from the rest? Here we illustrate the visible and invisible features that make Nordisk invincible.



1. New poles in all ss23 models

All models are delivered with new strong steel poles, coated with electrostatic powder for an exclusive finish; pin-free for tents, tarp poles have strong reversible pins for extra flexibility.

Heights are easily adjustable with a double click system, supported by an intuitive guide line.



2. Styling

You can always recognize a Nordisk tent on the classic Sandshell colour, the polar bear logos and the Danish Dannebrog flag label.

Product names are always printed next to the entrance.

3. Interior

Tents and inner cabins alike are designed to offer comfortable stand-up height and optimal light conditions to inspire energy and reflect the rhythm of the day. You will find gear loops in the ceiling that can also be used to attach sleeping cabins for added privacy and room division.

4. Updated Packsack

Our new packsacks are stronger, more protective and better looking than ever. They are extremely pack friendly, so even if compression is not optimal - you still have room to get your tent in. When doing a careful compression job, you can even fit it in with the Zip-in floor attached!



5. New Windows

All new models now feature n-shaped windows with double zips that can be operated from the inside and offer increased ventilation and outlook.

Two of the windows can be removed completely and replaced with a zip-in stove exit, so you do not have to compromise your precious Nordisk tent to use the Torden Wood Burner inside (bought separately).



6. Ground Sheet

Your optional re-enforced ground sheet works as a Zip-in floor, with complete water protection and makes the Nordisk tent both much more comfortable and suitable for all-year use.

The ground sheet is pegged to the ground with strong D rings.



7. Construction

Even though we take pride in making classical and simplistic looking tents, we go out of our way for innovating with near-invisible functionality.

The patented Norisk Turtle Hub® system has helped us create pin and eyelet-free constructions that will increase strength, ease pitching and remove weak spots where water could potentially enter the construction.

In several models, we have come up with tarp-like experiences to create a 360° outlook from inside. Roll up the sides on your Asgard, open up your Midgard or try the new Utgard or Ydun Sky!

You will always find multiple ventilation options throughout the tents. The Technical Cotton fabric is extremely breathable and ensures a pleasant inner climate and a reduced or no condensation experience.



8. Lines and Loops

Throughout our tents, you will only find quality guy line mounted with strong D-rings and our innovative adjustment sliders to make sure your tent is always looking and performing at its best.

We have introduced singular peg points for easy pitching, along with strong and adjustable webbings that allow you to adjust skirts and protect them from dirt and rain.



9. Entrance

Nordisk Legacy tents always feature a large 2-layer entrance, with mosquito mesh, YKK zippers and dedicated storage space for keeping the doors open.

From SS23, a magnetic snap-closure is added to the outer door for extra convenience.

NEW Nordisk Technical Cotton

SPIRIT

The Nordisk Technical Cotton fabric is designed to offer a truly extraordinary tent experience!

The natural cotton offers a unique and breathable inner climate, and the mix with man-made fibres reduces weight and adds durability and weather performance.

2023 TC Update:

PFC free water repellent (DWR)

Adding to the natural water protection from cotton expansion, we have developed a PFC free and European produced water repellent treatment to further strengthen the performance of the Technical Cotton.

UV shield

UV radiation is the worst enemy of material deterioration. So to protect the material and extend lifetime of your tent, we have added a shield to reduce the speed of UV implications. It is called a UV absorber and is an invisible layer of protection and is completely environmentally friendly.

Skin protection - UPF factor +50

The Technical Cotton fabric construction and the engineered protective shield offer a high degree of UV skin protection from the volatile ultraviolet radiation. The factor is the highest possible and with 50+, you are protected against minimum 98% of the UV radiation.

Mold and fungus shield

Humidity, temperature fluctuations, and exposure to dirt and grime - all attack the fabric and can lead to mildew, fungicidal mold, and eventually... rot. Nordisk has added an effective protective property to the Technical Cotton which will inhibit fungus and will extend protection by as much as 75% compared to old generation technical cotton.

These invisible updates will prolong the lifetime, improve the comfort and reduce the environmental impact of our entire range of cotton tents.

NORDISK™
Fabric Defence System



Get away from it all. Feel free and lighthearted.
Sense the vibe of these iconic tents and
listen to your heartbeat slowing down.

Reconnect with Mother Nature.



ALFHEIM 12.6/19.6 M²

Classic teepee cotton tent

- Can be pitched by one person
- Adjustable centre pole for an always perfect pitch
- Integrated internal ventilation system offers stargazing option

	Alfheim 12.6 m ²	Alfheim 19.6 m ²
Colour	Sandshell	Sandshell
Material flysheet	Technical Cotton 65% Polyester, 35% Cotton	Technical Cotton 65% Polyester, 35% Cotton
Material groundsheet	Zip-in floor available as add-on	Zip-in floor available as add-on
Net weight	12.700 g	19.700 g
Pack size	32 x 99 cm	36 x 99 cm
Item no.	142013	142014



DROMI FLAGLINE

Great way to decorate your camp

- 2 guylines in 1 package
- Adjustable flagline with hooks
- 11 flags on each guyline

Colour	Sandshell
Material flysheet	Technical Cotton 65% Polyester, 35% Cotton
Net weight	240 g
Pack size	23 x 23 cm
Item no.	148119

Dare to be different. Dare to go Denim

The first ever Nordisk Denim tent will really make your camp stand out. Bring your fashion style with you and enjoy a fantastic moment in nature.

So suit up with your jeans, your boots and your Asgard Denim tent. All you need is some rock'n'roll music, and you are ready for a picture perfect outdoor party.



SPIRIT

MAJOR UPGRADES ON:

Asgard 7.1 Denim and Asgard 7.1 / 12.6 / 19.6 m²
n-shaped windows / pinfree Turtle Hub[®]

NEW & UPDATED

NEW & UPDATED



ASGARD 7.1 DENIM

A well-known tent in cool denim style

- Stand-up height inside
- Large A-door protects against rain
- Adjustable pole height
- Alu poles and 20 cm stainless steel nails

	Asgard 7.1 m ² Denim (2.0)
Colour	Denim
Material flysheet	Technical Cotton 65% Polyester, 35% Cotton
Material groundsheet	150D Tarpaulin / sewn-in floor
Net weight	14.500 g
Pack size	30 x 97 cm
Item no.	10921008

ASGARD 7.1/12.6/19.6 M²

Versatile and cosy bell tent

- Stand-up height inside
- Large A-door protects against rain
- Adjustable pole height
- Large wall vents offer nice views
- Updated windows
- Updated larger door opening



	Asgard 7.1 m ² (2.0)	Asgard 12.6 m ² (3.0)	Asgard 19.6 m ² (3.0)
Colour	Sandshell	Sandshell	Sandshell
Material flysheet	Technical Cotton 65% Polyester, 35% Cotton	Technical Cotton 65% Polyester, 35% Cotton	Technical Cotton 65% Polyester, 35% Cotton
Material groundsheet	150D Tarpaulin / sewn-in floor	Zip-in floor available as add-on	Zip-in floor available as add-on
Net weight	16.400 g	17.500 g	19.700 g
Pack size	29 x 85 cm	27 x 93 cm	32 x 115 cm
Item no.	142063	142064	142069



Are you willing to sacrifice comfort and luxury when being outdoors? You don't have to. We love the generous space and spectacular appearance of Ydun and Utgard. **Enjoy nature to the fullest - without compromise.**

YDUN SKY 5.5 M²

The square and classic tent

- Full-width entrance in both ends
- Mesh windows with curtains
- Fantastic ventilation and indoor climate
- Pinfree polesystem
- 180° SKY Opening

Colour	Sandshell
Material flysheet	Technical Cotton 65% Polyester, 35% Cotton
Material groundsheet	150D Tarpaulin / sewn-in floor
Net weight	14.750 g
Pack size	30 x 66 cm
Item no.	142059



NEW & UPDATED

MAJOR UPGRADES ON:

Ydun sky 5.5 m² and Utgard sky 13.2 m²
Both with the new Nordisk Sky opening



Upgraded wheels, stronger & wider grip

COTTON CANVAS WAGON

Bring all your gear at once with this sturdy wagon

- Large, sturdy wheels keep the wagon stable through all terrains
- Ready to go in seconds
- Canvas carry bag allow for wheeled transport when folded

Colour	Sandshell
Measurements	94 x 64 x 50 cm
Material	Cotton Canvas
Net weight	13.200 g
Max. load	100 kg
Vol.	160 L
Pack size	82 x 40 x 23 cm
Item no.	127012



NEW & UPDATED



UTGARD SKY 13.2 M²

When a tent is almost like a real house

- Generous space
- 2 entrances
- Two large windows with curtains
- Updated sidewindow
- Pinfree polesystem
- 360° SKY Opening

Colour	Sandshell
Material flysheet	Technical Cotton 65% Polyester, 35% Cotton
Material groundsheet	Zip-in floor available as add-on
Net weight	23.100 g
Pack size	31 x 103 cm
Item no.	142061

Let the sun shine in

Introducing Utgard Sky and Ydun Sky

With the new Nordisk Sky opening, you will experience a whole new aspect of two classic Nordisk cotton tents. By simply unzipping the floor from the flysheet and raising the corners, you can create an open porch that invites nature into your nest. An integrated tarp solution that lets your tent truly stand out and the sun shine in.

Additionally, you will also discover that Utgard Sky and Ydun Sky can now be pitched pin-free, thus both strengthening the construction and removing any eyelets where rain could potentially enter your cabin.





An extremely spacious tent for extraordinary adventures

Vanaheim is a huge palace-like tent with two big windows in each end, lots of ground level D-windows and a large double entrance. With lots of ground area, it offers a vast range of possibilities for groups, events or a large family. Use it on a camp site or at home where you can decorate it with glamping décor for pure luxury - and if you want to install a double bed inside, the middle pole can be left out.



VANAHEIM 24/40 M²

Very spacious tent - nearly like a palace

- Lots of space for larger groups
- Pure villa atmosphere
- Great glamping possibilities



	Vanaheim 24 m ²	Vanaheim 40 m ²
Colour	Sandshell	Sandshell
Material flysheet	Technical Cotton 65% Polyester, 35% Cotton	Technical Cotton 65% Polyester, 35% Cotton
Material groundsheet	Zip-in floor available as add-on	Zip-in floor available as add-on
Net weight	43.400 g	55.200 g
Pack size	63 x 124 cm	72 x 124 cm
Item no.	142016	142020



A different Nordisk tipi with an attitude

With Thrymheim, the tipi shape has evolved into a modern hut where you can enjoy uninterrupted movement or placement of gear. Enjoy generous space, standing height and a cool tipi look with multiple variations of inviting the outdoor inside. The asymmetric designed inner tent offers an exciting and different inner space. Thrymheim offers Hygge® and being hip in nature with friends and family.

Be trendy. Set yourself apart in a versatile and noticeable way in nature.



THRYMHEIM 3/5

Pole free experience with great headroom and ventilation

- Tipi style hut with standing height – centre pole free experience via Turtle Hub® technology
- Inner mesh tent included in an asymmetric design
- Alu poles, alu pegs, alu sliders, reflective guy lines
- Mesh front door, 2 large mesh side windows
- Fully open front door option for great view and airflow
- Ground ventilation option in the back of tent
- Great mobility - attractive pack size and relative low weight
- 2 extendable alu tarp poles for the door canopy function sold separately

	Thrymheim3	Thrymheim 5
Colour	Picante/Cashew	Picante/Cashew
Material flysheet	100% Polyester, Rip-stop, PU	100% Polyester, Rip-stop, PU
Net weight	7.400 g	9.900 g
Pack size	22 x 55 cm	25 x 57 cm
Item no.	122055	122054

Be ready for a special camping experience.

Enjoy the precious time outdoors with your family and friends. Be prepared - Reisa will be the perfect and most convenient shelter for your family.



REISA 4/6

Spacious family camping tent

- Very easy to pitch
- Standing height
- Flexible living area
- Two separate cabins
- Doors convert into porch roof, extending the living area
- New rip-stop fabric for extra tensile strength

	Reisa 4	Reisa 6
Colour	Cashew	Cashew
Material flysheet	100% Polyester, Rip-stop, PU	100% Polyester, Rip-stop, PU
Net weight	11.600 g	18.900 g
Pack size	25 x 65 cm	35 x 70 cm
Item no.	122056	122057

**Our no. 1
bestseller**

COLOUR MY ADVENTURE

PERSONALISED. COLOURFUL. COMFORT.

THE PERFECT TENT FOR THE CREATIVE ARTIST

The Colour my Adventure concept offers you so much more than just a tent. It's your empty canvas ready for you to emphasize your personal style. Your creativity is the limit - our assortment of colourful accessories is just the beginning.

Make your tent stick out to show your personal style and as a bonus, it's much easier to find on the campsite - dare to be different and show your personality.

The concept in its simplicity: you choose your preferred tent, and then you add the tent accessories (pegs, poles, guy rope etc.) in the colour you love. Spice it up with different accessories in different colours, and you have yourself a colourful and personalized tent, ready for many new adventures.

Be prepared for
the attention
from other
campers - they
are just jealous.

New materials and innovation

Besides being a playful universe, Colour my Adventure is an innovative range of tents focusing on weight and packing size without compromising comfort. To find the perfect balance, materials are key. So, we created a whole new fabric which is a light and weather resistant cotton-like material. We added lightweight aluminium poles, pegs and trims, making you able to pack your entire Colour my Adventure tent into a backpack and carry it towards your next adventure - this has never been possible with a cotton tent before.

#ColourmyAdventure



Making camping colourful and fun - yet super easy and comfortable.

For a truly personalised camping adventure, design and functionality must go hand in hand. With the Colour my Adventure tents and tarp, you get a full-blown experience of creative design and remarkable technical features.

YDUN TECH MINI

Cosy ridge tent with a retro look and feel

- Innovative Turtle Hub® pole construction ensuring full and unhindered access
- Superb ventilation
- Two extendable vestibule front doors
- Personalise with Ydun Mini Colour Pack*

Colour	Sandshell
Material	Flysheet: Technical Hybrid Roof: Technical Nylon (100% Nylon, PU-coated, taped) Walls-Doors: Technical Cotton (65% Polyester, 35% Cotton)
Material groundsheet	100% Polyester, PU coated, taped / sewn-in floor
Net weight	4.300 g
Pack size	28 x 20 x 26 cm
Item no.	148051
Item no. colour pack	148052 / Mustard, 148053 / Cherry, 148054 / Chocolate

* needed for set-up



COLOUR PACKS

Bring happiness and colours to your camp. Each colour pack holds all accessories needed to pitch your tent or tarp:

- For Ydun Tech Mini, Asgard Tech Mini or Kari Mini
- Lightweight aluminium poles and pegs
- Reflective polyester guy rope
- Zipper pullers and clothes lines (*only for Ydun and Asgard Colour Packs)
- Available in three colours: Mustard Yellow, Cherry Pink and Chocolate Brown.

KARI MINI

Multifunctional tarp for extended camp area

- Made of light and technical cotton
- Various pitching options - 8 webbing loops plus eyelet
- Personalise with Kari Mini Colour Pack*

Colour	Sandshell
Measurements	300 x 250 cm
Material	Technical Cotton, 65% Polyester, 35% Cotton
Water column	350 mm
Net weight	1.900 g
Pack size	6 x 20 x 50 cm
Item no.	148062
Item no. colour pack	148059 / Mustard, 148060 / Cherry, 148061 / Chocolate

* needed for set-up



Remember to select a colour pack in your favorite colour

ASGARD TECH MINI

Airy and comfortable bell shape tent

- Innovative lightweight fabrics
- Closable mesh doors and windows
- Rainproof, quick-dry and all seams taped
- Personalise with Asgard Mini Colour Pack*

Colour	Sandshell
Material	Flysheet: Technical Hybrid Roof: Technical Nylon (100% Nylon, PU-coated, taped) Walls-Doors: Technical Cotton (65% Polyester, 35% Cotton)
Material groundsheet	100% Polyester, PU coated, taped / sewn-in floor
Net weight	4.300 g
Pack size	28 x 20 x 26 cm
Item no.	148055
Item no. colour pack	148056 / Mustard, 148057 / Cherry, 148058 / Chocolate

* needed for set-up



Start off your colourful adventure just right.

Often, we just consider what the adventure looks like on the camp site, but the adventure already begins when leaving home. Pack your Colour my Adventure tent and accessories in your favorite colour into the matching backpack.

Pack, go - and travel with style.



Bear Drop Pullers
Mustard. Item no. 148077
Cherry. Item no. 148078
Chocolate. Item no. 148079



Guy Lines
Mustard. Item no. 148073
Cherry. Item no. 148074
Chocolate. Item no. 148075



Flag Lines
Mustard. Item no. 148092
Cherry. Item no. 148093
Chocolate. Item no. 148094

SPIRIT



Large Hooks
Mustard. Item no. 148083
Cherry. Item no. 148084
Chocolate. Item no. 148085

#ColourmyAdventure

Accessories



Mini Hooks
Mustard. Item no. 148080
Cherry. Item no. 148081
Chocolate. Item no. 148082



YGG

Versatile urban daypack (25 l)

- Perfect for everyday use
- Useful daisy chains for attaching accessories and gear
- Top-loading with zip

Measurements	45 x 28 x 20 cm
Material	100% Nylon, PU-coated
Net weight	770 g
Vol.	25 L
Colour	Sand
Item no.	148049



YGGDRASIL

Convertible and functional backpack (22-37 l)

- Usable as Mini tent carry bag or as a travel bag
- Lightweight, sturdy and abrasion-resistant Technical Nylon
- Detachable and replaceable front pocket
- Useful daisy chains for attaching accessories and gear

Measurements	69 x 29 x 19 cm
Material	100% Nylon, PU-coated
Net weight	1.300 g
Vol.	22-37 L
Colour	Sand
Item no.	148050

Complete the look
Match your backpack to the rest of your adventure by choosing a colourful front pocket.

Easy to attach rain cover doubles as tote bag / shopping bag.

COLOUR YOUR ADVENTURE



Pocket
Mustard. Item no. 148095
Cherry. Item no. 148096
Chocolate. Item no. 148097



Aluminium Skewer Pegs
Mustard. Item no. 148066
Cherry. Item no. 148067
Chocolate. Item no. 148068



Thor's Hammer Pullers
Mustard. Item no. 148086
Cherry. Item no. 148087
Chocolate. Item no. 148088



Rain Cover
Mustard. Item no. 148098
Cherry. Item no. 148099
Chocolat. Item no. 148100



Name Boards
Mustard. Item no. 148089
Cherry. Item no. 148090
Chocolate. Item no. 148091



Polar Bear Key Hanger
Mustard. Item no. 148101
Cherry. Item no. 148102
Chocolate. Item no. 148103



The must-have outdoor accessory

Expand your tent, make an outdoor dining area with a roof or use it to shelter your favorite outside spot permanently against the elements. Kari tarps compliment the rest of our cotton range and can be used either with or without a tent to protect you and your camp from rain, wind or strong sun.



KARI 8/12/20/30/41 M²

The natural need-to-have add-on for your cotton tent

- Ideal for providing shade and shelter in sunny weather
- Perfect for providing protection against wind, rain and adverse weather
- Strong webbing loops and eyelets for various attachment and setup options
- Extra fast-attach guy lines with alu hook system
- Reinforced centre points with webbing and tarpaulin patch for poles, paddles, tree branches (not applied on Kari 8)
- Use with or without a tent
- Great for gathering and living with your camping community
- Designed to fit all Nordisk cotton tents

	Kari 8 m ²	Kari 12 m ² (2.0)	Kari 20 m ² (2.0)	Kari 30 m ²	Kari 41 m ²
Colour	Sandshell	Sandshell	Sandshell	Sandshell	Sandshell
Material	Technical Cotton 65% Polyester, 35% Cotton	Technical Cotton 65% Polyester, 35% Cotton	Technical Cotton 65% Polyester, 35% Cotton	Technical Cotton 65% Polyester, 35% Cotton	Technical Cotton 65% Polyester, 35% Cotton
Net weight	8.000 g	8.600 g	10.900 g	13.200 g	17.500 g
Pack size	21 x 60 cm	15 x 78 cm	18 x 78 cm	22 x 75 cm	23 x 80 cm
Item no.	142035	142038	142039	142036	142037

KARI ALU POLE SET

Made to fit the Kari 12 but can be used for any tarp setup

- Low weight and high strength
- High grade alloy aluminum
- Extendable / adjustable system (from 240 - 260 cm)
- Good grip to any ground surface
- Pin to attach to webbing loops or eyelets



Measurements	Diameter 25/28 mm Length 240-260 cm
Material	Anodized Aluminium
Net weight	1.650 g
Pack size	65 x 15 cm
Item no.	107276

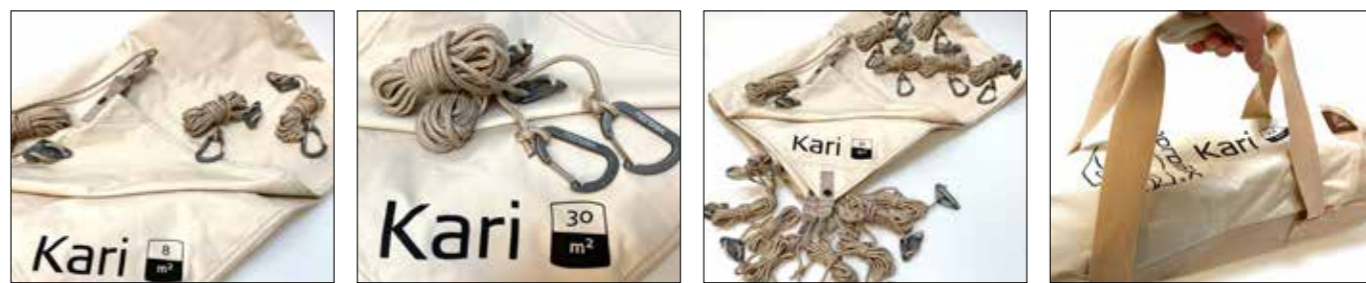



HAMARR

Stylish and convenient peg hammer

- Slightly curved wooden handle
- Practical hook to pull out pegs
- Leather strap

Measurements	30 x 11 x 3,5 cm
Material	hardened steel, brass, hard wood, leather.
Net weight	620 g
Item no.	109093

HAMARR REPLACEMENT HEAD

Easy to replace

- Brass as the original to absorb the hard strike
- includes tool to take out the pin and a new pin to insert

Measurements	10L x 4 cm Ø
Material	Brass, steel pin
Net weight	160 g
Item no.	109095



FOLDABLE MEASURE CUP

A great tool for the outdoor kitchen

- Classic measure cup with foldable handle
- Stainless steel
- Serve, pour, eat, drink, all purpose measure cup
- Heat resistant

NEW

Measurements	Ø 12 cm x 4,5 cm
Material	Stainless steel
Net weight	100 g
Capacity	300 ml
Item no.	119012



ALUMINIUM KETTLE

A true classic kettle

- Comes with a multi-purpose cotton canvas storage bag
- Lightweight hard anodized aluminium
- Suitable for camping gas stoves

Measurements	15 x 13 cm
Material	Hard anodized aluminium body Wood handle
Net weight	225 g
Vol.	1,3 L
Colour	Charcoal
Item no.	127010

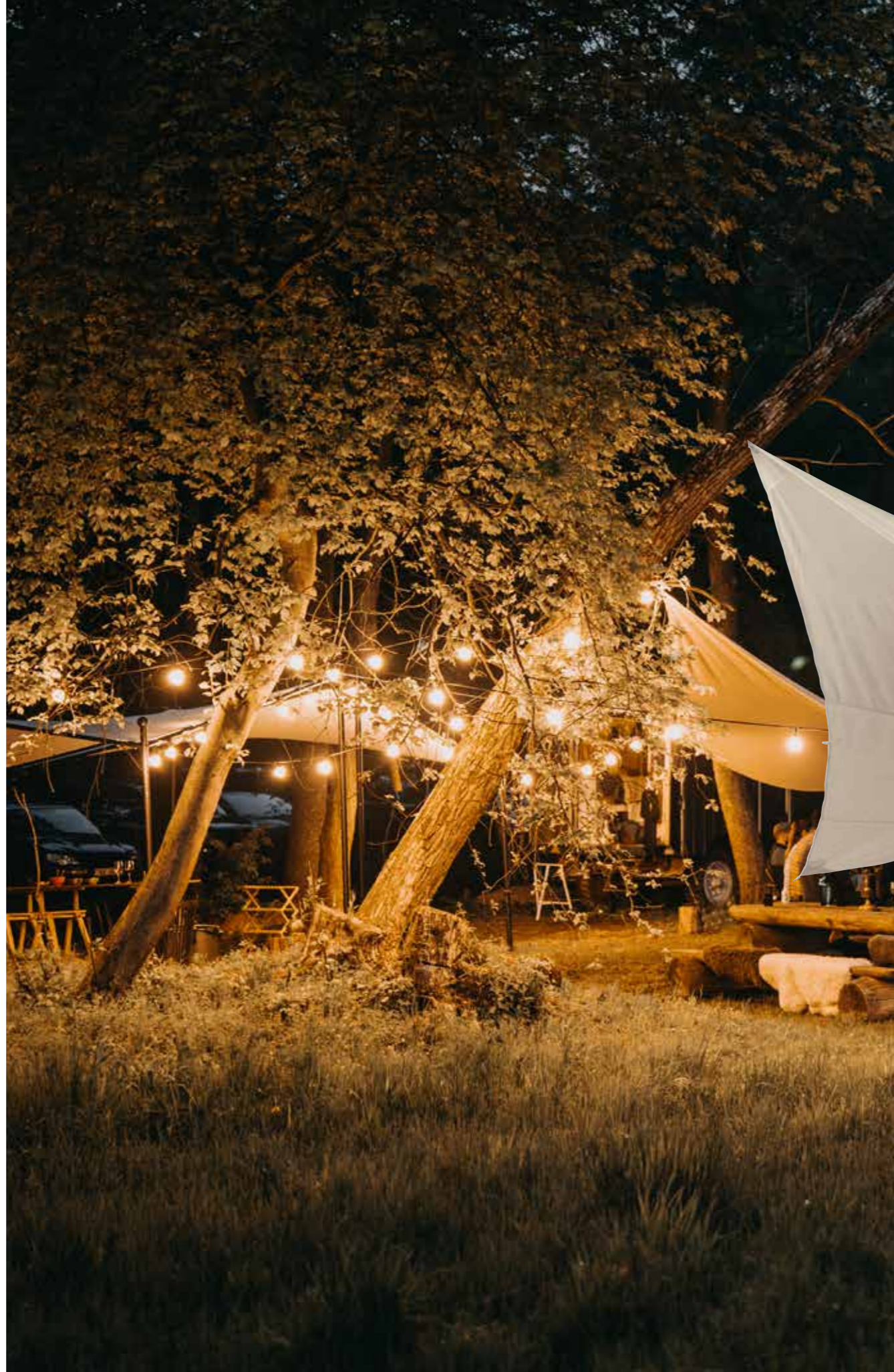

Be the creator of your very own cotton glamping universe.

The Nordisk cotton tarps are gathering family and friends on your next glamping adventure.

KARI DIAMOND 10/20 M²

Large cotton tarp offering extra space

- Diamond shaped tarp
- Ideal for shade and rain shelter
- Large extra exterior space
- Strong webbing loops and eyelets for various attachment and setup options
- Extra fast-attach guy lines with alu hook system
- Reinforced centre points with webbing and tarpaulin patch for poles, paddles, tree branches

UPDATED

	Kari Diamond 10 m ² (2.0)	Kari Diamond 20 m ² (2.0)
Colour	Sandshell	Sandshell
Material	Technical Cotton 65% Polyester, 35% Cotton	Technical Cotton 65% Polyester, 35% Cotton
Net weight	6.500 g	9.900 g
Pack size	14 x 87 cm	17 x 79 cm
Item no.	142040	142041

Create lifetime memories around the campfire. Enjoy the moment to the fullest and don't worry about freezing at night.
We have you covered - in the true sense of the word.

NORDISK®
 ORGANIC COTTON



ALMOND +10°/-2°

Classical and snug sleeping bag

- 100% Organic Cotton shell and lining
- Extremely soft flannel chequered lining
- Converts into a blanket



Colour	Bungy Cord
Sizes	S + L
Shape	Blanket
Shell material	100% Organic Cotton
Lining material	Yarn dyed jacquard, 100% Organic Cotton Flannel
Filling	Norguard Unlimited
Net weight	1.200-2.000 g
Temperature	+13° +10° -3° / +3° -2° -19°



MOS DOWN SLIPPERS

Keeping your feet warm

- Extremely soft
- Packable
- Anti-slip sole



Size	XS(31-34), S(35-38), M(39-42), L(42-44)
Material	Nylon & Polyester
Filling	Down
Weight	135-210 g
Colour	Dress Blue Arona Sandshell
Item no.	109072



SPIRIT

MUG

Steel mug

- Double wall vacuum insulated construction will keep your hot drinks hot and cold drinks cold
- Non-slip bottom surface
- Dishwasher safe



Colour	Dress Blue Arona Sandshell
Volume	300 ml
Size	7 x 10 cm
Material	Stainless steel
Weight	150 g
Item no.	122072



BOTTLE

Steel drinking bottle

- Double wall vacuum insulated construction will keep your hot drinks hot and cold drinks cold
- Rust free, leak free design
- Non-slip bottom surface
- Carabiner included for easy attachment to your bag
- Dishwasher safe



Colour	Dress Blue Arona Sandshell
Volume	500 ml
Size	7,3 x 23 cm
Material	Stainless steel
Weight	350 g
Item no.	122073





CHECK IN TO NATURE'S OWN BILLION-STAR HOTEL

A relaxing outdoor camping experience calls for a great sleeping bag. Puk is designed to be your reliable sleeping-buddy, with all the features you need for a good night's sleep.

Good night - see you well-rested in the morning.



PUK +10° Blanket

Perfect companion for warmer climates offering very high freedom of movement

- Extreme small pack size - take it with you everywhere you go!
- Use as blanket or sleeping bag - indoors and outdoors during hot summer nights
- 2-way complete zip with jam guard



Colour	Sun-dried Tomato/Majolica Blue/Syrah
Sizes	M-L
Shape	Blanket
Shell material	100% Brushed Polyester, 30D
Lining material	100% Nylon, 30D
Filling	Norguard S-PO 80
Net weight	650-760 g
Temperature	+15° +10° -2°



PUK +4° Egg

Comfortable and spacious sleeping bag to secure a good night's sleep during most summer nights

- Plenty of room for movement, and the option to open wide with the complete zip
- Comfortable footbox and contoured hood
- 2-way complete zip with jam guard



Colour	Sun-dried Tomato/Majolica Blue/Syrah
Sizes	M-L
Shape	Egg
Shell material	100% Brushed Polyester, 30D
Lining material	100% Nylon, 30D
Filling	Norguard S-PO 80
Net weight	805-930 g
Temperature	+9° +4° -8°



PUK -2° Blanket

Spacious and warm multi-purpose sleeping bag for three seasons

- Use as a blanket or sleeping bag on the campsite or on a boat cruise
- Internal thermal collar to keep the warmth inside on colder nights
- 2-way complete zip with jam guard



Colour	Sun-dried Tomato/Majolica Blue/Syrah
Sizes	M-L
Shape	Blanket
Shell material	100% Brushed Polyester, 30D
Lining material	100% Nylon, 30D
Filling	Norguard S-PO 80
Net weight	1.530-1.740 g
Temperature	+5° -2° -18°

Wrap yourself
in pure warm air.



KIBY

Lightweight down-filled blanket

- Blanket converts into a travel pillow
- Extremely light and fluffy
- The perfect Hygge® companion on the couch or on the go



Colour	Coal Grey / Black Coal Grey / Cranberry Red Arctic Night
Size (cm)	200 x 140
Top material	Polyester / nylon melange
Back material	Lightweight rip-stop polyester
Filling	Crystal Down® 90/10 European Down EU Standard: 600+ cuin US Standard: 650+ cuin
Filling weight	290 g
Net weight	570 g
Construction	Stitched through
Item no.	5032

HERMOD DOWN SLIPPERS

Cosy and warm classic down slippers

- Very soft European down
- Ultrasoft lining
- Gives you a cosy and warm feeling

Size	XS-S-M-L
Material shell	100% Organic Cotton
Material lining	100% Polyester Fleece 100% Organic Cotton Flannel
Filling	Down
Net weight	135-210 g
Colour	Bungy Cord
Item no.	109090



NORDISK®
ORGANIC COTTON



Always on the lookout for
that extra little something?

The feature-packed Voyage bag offers
extraordinary sleeping comfort and a
down filled stuffsack that doubles as
a footbox to keep your toes warm and
happy throughout the night.

Bon Voyage, everyone.



VOYAGE 300/500

Ultimate sleeping comfort

- Elastic panels on both sides for a snug, yet flexible fit
- Down-filled stuffsack can also be used as foot warmer or pillow



Colour	Ribbon Red / Black
Sizes	M-L-XL
Shape	Mummy
Shell material	Lightweight rip-stop nylon
Lining material	Lightweight rip-stop nylon
Filling	Crystal Down® 90/10 600+ European down 600+ cuin (EU) / 650+ cuin (US)
Net weight	800-1.200 g
Temperature	+6° +1° -14° / 0° -5° -22°



A bag for everyone - also available in kids size

Wake up. Without an alarm. Listen to nature around you - it will vitalize you. But before you get up for a new day full of adventures, enjoy an extra minute in your warm and cozy sleeping bag.

A classic high-quality sleeping bag to fit any adventure. Comes in all shapes and sizes.



TENSION MUMMY 300/500

Perfectly fitted for the body contour - wide across the chest and narrower by the feet giving a great fit with optimal insulation properties.

- Highly breathable
- Adjustable contoured hood
- Available in +1° and -2°

Colour	Scarab / Lime
Sizes	M-L-XL
Shape	Mummy
Shell material	Lightweight Nylon
Lining material	Lightweight Nylon
Filling	Crystal Down® 90/10 600+ European down 600+ cuin (EU) / 650+ cuin (US)
Net weight	700-1.100 g
Temperature	+6° +1° -15° / +3° -2° -18°



TENSION COMFORT 300/600/800

Freedom of movement at its most. A good balance between insulation and space provides good warmth and plenty of room for a comfortable night's sleep.

- Oversized for extra comfort
- Highly breathable
- Adjustable contoured hood
- Available in +3°, -3° and -6°

Colour	Scarab / Lime
Sizes	M-L-XL
Shape	Egg
Shell material	Lightweight Nylon
Lining material	Lightweight Nylon
Filling	Crystal Down® 90/10 600+ European down 600+ cuin (EU) / 650+ cuin (US)
Net weight	790-1.460 g
Temperature	+8° +3° -10° / +3° -3° -20° / -1° -6° -23°



TENSION BRICK 200/400/600

Designed with maximum comfort in mind. Ideal if you tend to move around in your sleep or if you prefer a sleeping bag that doubles as a blanket.

- Spacious and comfortable sleeping bag
- Highly breathable
- Adjustable contoured hood (*excl. Tension Brick 200)
- Converts into a blanket
- Available in +13°, -1° and -4°

Colour	Scarab / Lime
Sizes	M-L-XL
Shape	Blanket
Shell material	Lightweight Nylon
Lining material	Lightweight Nylon
Filling	Crystal Down® 90/10 600+ European down 600+ cuin (EU) / 650+ cuin (US)
Net weight	600-1.300 g
Temperature	+16° +13° +4° / +5° -1° -16° / +2° -4° -20°





Even tiny adventurers need a good night's sleep. With a sleeping bag fitted to kids, comfort is guaranteed.

For extra Hygge®, add a cuddly polar bear.

TENSION JUNIOR

A high quality down-filled sleeping bag to fit any adventure

- Premium European down
- Expandable design
- Extra breathable



CRYSTAL DOWN

Body length	130-160 cm
Shell material	Nylon
Lining material	Nylon
Filling	Crystal Down® 90/10 600+ European down 600+ cuin (EU) / 650+ cuin (US)
Pack size	27 x 16 cm
Net weight	680 g
Temperature*	Approx. +10° to +14°
Season	3-season
Shape	Mummy
Item no.	84821 Scarab / Lime



*Standard temperature testing according to EN13537 is not applicable for children's sleeping bags. For tiny tots and young adventurers, we therefore provide a NORDISK temperature range recommendation that takes into account the subjective sensation of cold, depending on age, physique and activity level.

POLAR BEAR

Our iconic Nordisk Polar Bear as your cute sleeping buddy



- Perfect for fans or as promotional item
- 10, 15 or 35 cm tall
- CE-marked and European standard for toys (EN71)

	Small	Large	Key Hanger
Measurements	10 x 15 cm	18 x 35 cm	7 x 10 cm
Material	Polyester	Polyester	Polyester
Net weight	32 g	270 g	20 g
Item no.	149006	149007	149008





NEW COLOUR

NEW

PUK JUNIOR

Great adventure sleeping bag for kids

- Designed for kids in the growing age
- Expandable design
- Supersoft Norguard S-PO 80 filling inside
- Extra warm foot section for smaller kids
- Practical zipped inner pocket
- Easy-to-pack compression pack sack
- No velcros and entangling draw cords inside the bag

Body length	130-170 cm
Shell material	100% Brushed rip-stop Polyester, 30D
Lining material	100% Nylon, 30D
Filling	Norguard S-PO 80
Pack size	20 X 26.5 cm
Net weight	760 g
Temperature*	Approx. +11° to +7°
Season	Summer
Shape	Mummy
Item no.	110350 Sun-dried Tomato / Majolica Blue

PUK SCOUT

Great 3-seasons kids sleeping bag designed to grow as you go

- Expandable design
- Supersoft Norguard S-PO 80 filling inside
- Extra warm foot section for smaller kids
- Built-in pillow sleeve for pillows or clothes
- Soft thermal collar for keeping kids warm
- Practical zipped inner pocket
- No velcros and entangling draw cords inside the bag
- Dual-purpose storage bag - "Mesh Bag" for storage or "Meditation Biscuit" can be used as seat cushion or pillow
- Easy-to-pack compression pack sack

Body length	130-170 cm
Shell material	100% Brushed Polyester, 30D
Lining material	100% Nylon, 30D
Filling	Norguard S-PO 80
Pack size	22 x 28 cm
Net weight	1.080 g
Temperature*	Approx. +7° to +3°
Season	3-season
Shape	Mummy
Item no.	110351 Sun-dried Tomato / Majolica Blue

*Standard temperature testing according to EN13537 is not applicable for children's sleeping bags. For tiny tots and young adventurers we therefore provide a NORDISK temperature range recommendation that takes into account the subjective sensation of cold, depending on age, physique and activity level.

Upgrade your sleeping bag!

Give your sleeping bag a temperature boost by taking one of these indispensable downliners with you into the sleeping bag. By adding down insulation and minimizing the room for cold air, you automatically turn your old sleeping bag into a more comfortable and warmer nest for the night.



COSY FEET

Warm foot muff

- Downliner gives instant heat
- Easy to bring along
- Fits into all sleeping bags
- For comfortable use when traveling



Colour	Scarab / Lime
Size (cm)	50 x 40
Material	Recycled nylon
Filling	Crystal Down® 90/10 600+ European down 600+ cuin (EU) / 650+ cuin (US)
Filling weight	35 g
Total weight	120 g
Construcion	Stitched through
Item no.	5038

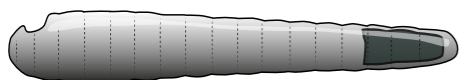

COSY LEGS

Warm short bag

- Downliner gives instant heat
- Easy to bring along
- Fits into all sleeping bags
- For comfortable use when traveling



Colour	Scarab / Lime
Size (cm)	S/M 70 x 40 x 120 - L/XL 70 x 40 x 140
Material	Recycled nylon
Filling	Crystal Down® 90/10 600+ European down 600+ cuin (EU) / 650+ cuin (US)
Filling weight	90 g (L/XL)
Total weight	300 g (L/XL)
Construcion	Stitched through
Item no.	S/M 5039 - L/XL 5040



3 AM. You wake up shivering. The temperature has turned out to be a lot lower than anticipated. Your bag is simply not warm enough.

Well... here's the answer to your frozen prayers.

Upgrade your sleeping bag by inserting a downliner that gives a temperature boost and that fluffy down feeling and feel the heat returning to your body in an instant. Or use it as a standalone product by the fire when night sets in.

And ssch! Go back to sleep, now!

COSY COVER

Warm cover with foot box

- Downliner gives instant heat
- Easy to bring along
- Fits into all sleeping bags
- For comfortable use when traveling



Colour	Scarab / Lime
Size (cm)	S/M 170 x 100 x 45 - L/XL 190 x 110 x 50
Material	Recycled nylon
Filling	Crystal Down® 90/10 600+ European down 600+ cuin (EU) / 650+ cuin (US)
Filling weight	110 g (L/XL)
Total weight	350 g (L/XL)
Construcion	Stitched through
Item no.	S/M 5041 - L/XL 5042

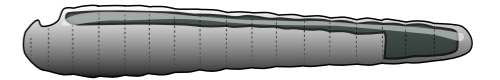

Talking and laughing until late at night.
 Enjoy camp life at its best and be sure that
 your good night's sleep will be just as good
 and comfy as in your bed at home.
Or even better.



ALDEN 10.0 XL SELF-INFLATABLE MAT

Very Comfortable and extra thick mat with rounded corners

- Swapside features - both sides made from same fabric in two different attractive colors
- Soft stretch material for better comfort
- Noise reducing fabric

ALDEN 10.0	Extra large Rectangular
Colour	Reflective Pond / Sandshell
Measurements	200 x 75 x 10 cm
Material front	20D Stretch Polyester, 100% Polyester
Material back	20D Stretch Polyester, 100% Polyester
Net weight	2.700 g
Pack size	28 x 42 cm
Foam	16 kg/m ³ PU
Item no.	114052



ALDEN 5.0 S/M/L SELF-INFLATABLE MAT

Very Comfortable mats with rounded corners

- Swapside features - both sides made from same fabric in two different attractive colors
- Soft stretch material for better comfort
- Noise reducing fabric

ALDEN 5.0	Small Mumieshape	Medium Rectangular	Large Rectangular
Colour	Reflective Pond / Sandshell		
Measurements	168 x 51 x 5 cm	183 x 66 x 5 cm	200 x 75 x 5 cm
Material front	20D Stretch Polyester, 100% Polyester		
Material back	20D Stretch Polyester, 100% Polyester		
Net weight	1100 g	1.400 g	1.800 g
Pack size	16 x 26 cm	18 x 34 cm	20 x 39 cm
Foam	16 kg/m ³ PU		
Item no.	114046	114048	114050



ALDEN 5.0 CUSHION

Colour	Reflective Pond / Sandshell
Measurements	43 x 30 x 5 cm
Material front/back	20D Stretch Polyester, 100% Polyester
Net weight	200 g
Pack size	9,5 x 17,5 cm
Foam	16 kg/m ³ PU
Item no.	114044



Pillows	Morgen	Aften	Dag	Nat
Colour	Sandshell	Sandshell	Reflective Pond	Reflective Pond
Measurements	35 x 35 x 8 cm	35 x 20 cm	80 x 30 cm	42 x 30 cm
Material front	Brushed Polyester, 75D x 150D	100% Cotton Jersey	100% Cotton Jersey	100% Cotton Jersey
Material back	Oxford Polyester, 150D	100% Polyester	100% Polyester	100% Polyester
Net weight	230 g	100 g	175 g	110 g
Pack size	8 x 35 cm	9 x 5 x 10 cm	6 x 11 x 11 cm	9 x 5 x 10 cm
Foam	Solid foam	TPU air pocket with synthetic filling	TPU air pocket with synthetic filling	TPU air pocket with synthetic filling
Item no.	10621035	10621036	10621037	10621038

Carry your gear with style.

With the Karlstad and Kongsberg duffel bags, you have the perfect travel companions for every activity - in nature and the urban jungle.

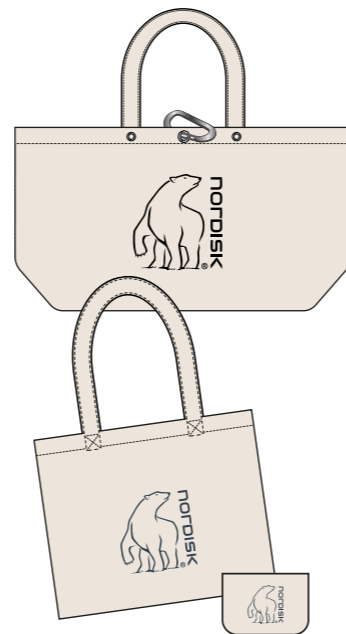

NEW COLOURS

KARLSTAD 27 DUFFEL

Convertible duffel with dual packing compartment

- Converts between cross shoulder bag and backpack
- Extremely robust and durable cotton canvas
- Interior zip pocket
- Top loading with dual zipper compartments



Colour	Cookie Brown / Four Leaf Clover / Dark Gull Grey / Mojave Desert
Vol.	27 L
Measurements	55 x 25 cm
Material	100% Cotton
Net weight	700 g
Item no.	143025 Cookie Brown 143026 Four Leaf Clover 143029 Dark Gull Grey 143032 Mojave Desert

TOTE BAG

Colour	Natural
Item no.	143003
	100% organic cotton, heavy canvas, pocket inside with zipper, aluminium hook
Item no.	133110
	100% organic cotton, lightweight plain weave, packable, pocket with velcro

NEW COLOURS

KONGSBERG 40/65 DUFFEL

Classic and spacious duffel bag

- Easy to pack and unpack
- Heavy duty cotton canvas
- External patch pocket & interior zip pocket
- Top loading with zipper opening (Kongsberg 40) or hook & latch opening (Kongsberg 65)



	Kongsberg 40 Duffel	Kongsberg 65 Duffel
Colour	Cookie Brown / Four Leaf Clover / Dark Gull Grey / Mojave Desert	
Vol.	40 L	65 L
Measurements	50 x 29 x 29 cm	77 x 29 x 29 cm
Material	100% cotton	100% cotton
Net weight	750 g	1.100 g
Item no.	143006 Cookie Brown 143007 Four Leaf Clover 143027 Dark Gull Grey 143030 Mojave Desert	143005 Cookie Brown 143008 Four Leaf Clover 143028 Dark Gull Grey 143031 Mojave Desert

Take your adventures with you.

We have a suitable solution for every endeavour.

VERRAN WHEELED DUFFEL 45/115 L

Wheeled duffel for heavy gear

- Several internal pockets for easy organizing
- Haul handle at top
- Folds flat for easy storage



	Verran Wheeled Duffel 45 L	Verran Wheeled Duffel 115 L
Colour	Forest Green / Burnt Red	Forest Green / Burnt Red
Vol.	45 L	115 L
Measurements	53 x 38 x 24 cm	81,5 x 42 x 36 cm
Material	100% Polyester	100% Polyester
Net weight	2.500 g	4.000 g
Item no.	133101 Forest Green 133102 Burnt Red	133103 Forest Green 133104 Burnt Red



TINN 24 BACKPACK

One backpack for all your needs

- Multiple compartments and pockets
- Engineered back panel for increased comfort and ventilation
- Water-repellent bottom



Colour	Magnet / Burnt Red
Vol.	24 L
Measurements	48 x 30 x 20 cm
Material	100% Polyester
Net weight	714 g
Item no.	133098 Magnet 133099 Burnt Red



HALMSTAD 12 MESSENGER

Urban messenger for everyday and business use

- Padded laptop department
- Internal organisation and key clip
- Adjustable shoulder strap



Colour	Magnet / Burnt Red
Vol.	12 L
Measurements	40 x 30 x 11 cm
Material	100% Polyester
Net weight	650 g
Item no.	133096 Magnet 133097 Burnt Red



RIBE

Handy for many purposes

- Ultra sturdy and ultra packable
- Extremely strong Cordura rip-stop fabric
- Shoulder straps with mesh for ventilation



Colour	Black
Vol.	20 L
Measurements	26 x 35 x 22 cm
Material	Cordura Nylon, 30D
Net weight	120 g
Item no.	133018



NIBE

Extremely small, durable and spacious

- Ideal as an extra bag when travelling
- Pack size like a small wallet
- Extremely strong Cordura rip-stop fabric



Colour	Black
Vol.	12 L
Measurements	22 x 32 x 10 cm
Material	Cordura Nylon, 30D
Net weight	70 g
Item no.	133019



Gather your loved ones.
 Invite them to your home
 outside home. Enjoy your
 time outdoors together
 and feel the happiness.
Time is now.



MARIELUND CHAIR

Comfortable lightweight chair

- Easy to set up
- Strong and durable
- Zipped carry bag

Colour	Sandshell
Measurements	H70 x D52 x W49 cm
Material	100% Polyester, 600D / aluminium frame
Net weight	1.209 g
Max. load	145 kg
Pack size	11 x 40 cm
Item no.	149057



RISSKOV TABLE

Portable lightweight camping table

- Hard surface tabletop with fabric cover and two cupholders
- 2 built-in cupholders
- Zipped carry bag

Colour	Sandshell
Measurements	H39 x D58 x W43 cm
Material	100% Polyester, 600D / aluminium frame
Net weight	928 g
Max. load	145 kg
Pack size	12 x 40 cm
Item no.	149058



KONGELUND LOUNGE CHAIR

Portable Lounge Chair with higher back rest

- Comfortable and cosy
- Low weight
- Zipped carry bag

Colour	Sandshell
Measurements	H99 x D80 x W50,5 cm
Material	100% Polyester, 600D / aluminium frame
Net weight	1.720 g
Max. load	145 kg
Pack size	14 x 52 cm
Item no.	149056

The range of lightweight furniture from Nordisk has the perfect balance of comfort, functionality and weight to suit both hiking and glamping adventures.

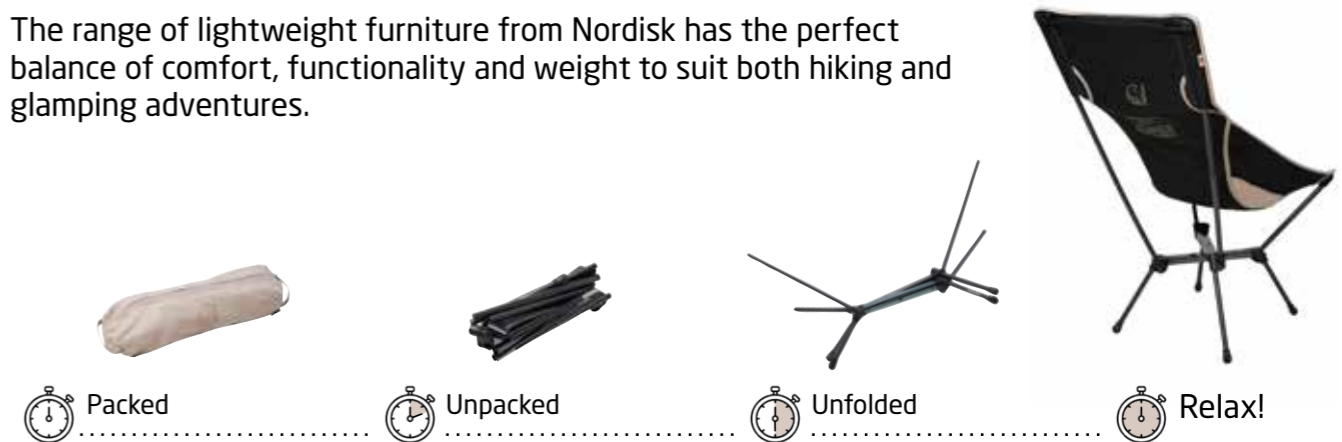



What is a home without furniture?

Equip your camp and bring extra Hygge® to it. Enjoy the comfort and luxury of stylish design furniture.



Danish Design
Produced in Europe

MOESGAARD WOODEN CHAIR

Ideal lounge chair for relaxing

- Easy to assemble and pack - no tools needed
- Green choice: 100% natural product
- Transport packsack included

Colour	Sandshell
Measurements	92 x 82 x 67 cm
Material	100% natural linen, 100% beech wood, 100% natural sisal
Net weight	5.500 g
Max. load	100 kg
Pack size	15 x 105 cm
Item no.	149010



Danish Design
Produced in Europe

MARSELIS WOODEN BED

1960's inspired retro wooden bed

- Very comfortable camp bed
- Transport packsack included
- Stylish and perfect for glamping

Colour	Sandshell
Measurements	35 x 200 x 80 cm
Material	100% natural linen, 100% beech wood, 100% natural sisal
Net weight	10.000 g
Max. load	100 kg
Pack size	15 x 205 cm
Item no.	149011



REBILD WOODEN TRIPOD

Comfy retro camping tripod

- Small pack size with canvas carry bag
- Comfortable and elevated seating
- Durable and sturdy

Colour	Sandshell
Measurements	50 x 40 x 40 cm
Material	100% Cotton canvas / Beech wood
Net weight	1.200 g
Max. load	120 kg
Pack size	64 x 15 cm
Item no.	149018



ROLD WOODEN BED

Classic foldable camp bed

- Small pack size
- Can be used as couch
- Cotton canvas carry bag

Colour	Sandshell
Measurements	40 x 191 x 65 cm
Material	100% Cotton canvas / Beech wood
Net weight	8.400 g
Max. load	120 kg
Pack size	100 x 20 x 18 cm
Item no.	149019



Use our Aluminium Kettle or the Madam Blå Coffee Pot on top of the Torden stove when boiling water for your coffee or tea.

Sitting around a warm stove, sipping freshly-brewed coffee, talking about the experiences of the day.

This is what we call a true outdoor Hygge® moment. The fire draws you into an inner peace and relaxation. Looking at the different colours of the fire, listening to the crackling of the wood burning and feeling the heat when everything is getting colder around you. At this moment you feel alive.

Danish Design
Produced in Europe

TORDEN WOOD BURNER SET

The ultimate Hygge® experience. Get the warm and cosy atmosphere of the campfire with this Nordisk stove in a raw design.

- Outdoor wood burner
- Easily boil water for coffee or tea
- Integrated ashtray
- Two dry handles for drying your wet gloves, warming a piece of bread or keeping your coffee hot
- Comes in a durable and cool bag
- Two stove connectors to choose between a side exit (horizontal) or a top exit (vertical)

Measurements	39 x 29 x 36 cm
Material	Hard steel
Net weight	13.500 g + base 3.500 g
Colour	Charcoal Grey
Item no.	10421010



TORDEN CHIMNEY EXIT

- Closes the hole when Torden is not in use
- Safe to use in all Nordisk cotton tents

Measurements	30 x 35 cm
Material	Technical Cotton, Fiberglass
Net weight	400 g
Colour	Sandshell
Item no.	10421011



TORDEN CHIMNEY WINDOW

- Zip-in chimney exit that replaces a window
- No need to cut a hole in your tent
- Available for the n-shaped windows of Asgard 12.6, 19.6 and Utgard 13.2

	Asgard 12.6	Asgard 19.6	Utgard 13.2
Material	Technical Cotton, Fiberglass		
Colour	Sandshell		
Item no.	10901012	10901013	10901014



TORDEN CHIMNEY PIPE SET

- Practical and cool bag for storage and transportation
- Segment length 31 cm - total length 213 cm (230 cm incl spark arrest)
- Easy to assemble
- Different setup options

Material	Stainless steel
Net weight	3.600 g
Colour	Steel Look
Item no.	10421009



TORDEN LEATHER GLOVES

These leather gloves will protect you against heat and sharp edges when firing up your Torden wood burner.

- Durable, so they will guard you for a long time
- Genuine Leather
- Lined for optimal heat protection
- Complete set of left and right hand gloves

Material	Genuine Leather
Size	One size fits all
Net weight	370 g
Colour	Brown/Black
Item no.	149034



Madam Blå



A true icon
- reborn by Nordisk



Madam Blå - reborn by Nordisk

In 1895, ironmongers started making enamelled kitchen equipment and quickly got famous for their Madam Blå coffee pot. Madam Blå turned into an iconic line of kitchenware - now re-introduced by Nordisk as a celebration of its 125 years history and inevitable part of Danish Hygge culture, which deservedly earned it its place in our National Museum.

Our Madam Blå is handmade, unique and can last for generations. Every use will leave a subtle mark, so every story and every adventure can be passed on to your children and grandchildren.

At Nordisk, we love our Danish heritage and the nostalgic style, because it brings out happy memories from when we were younger, sitting at the kitchen table with our grandparents, enjoying countless Hygge® moments. Products like these keep our memories going and the longing for these Hygge® times alive.



**Madam Blå..?
Blu..? Blo..?**

The letter Å is a letter used in all scandinavian languages and was introduced in the 1400s as a combination of the letters A and O. It is pronounced closely to the sound of the A in *talk*.

Why not go all the way when designing your glamping experience? Look back at good memories and create your own while spending time with your loved ones, sipping coffee from a cup full of nostalgia. Enjoy a true Hygge® moment.

Because in the moment - we create our memories!

MADAM BLÅ COFFEE POT

The nostalgic Coffee Pot from Denmark

- Eyecatcher on every table
- Ideal for all hot and cold beverages
- All-in-one brewing station
- Detachable brewing compartment



Colour	Sky Blue / Cream
Measurements	Ø14 x 26 x 27 cm
Capacity	1,5 L
Net weight	900 g (pot 600 g)
Material	Enemal coated steel
Item no.	10421007



MADAM BLÅ BOWL

Functional enamel bowl

- Perfect for cereals or soup
- Stylish look
- Sturdy material



Colour	Sky Blue / Cream
Measurements	15,5 x 7 cm
Capacity	800 ml
Net weight	210 g
Material	Enemal coated steel
Item no.	10421005



MADAM BLÅ PLATE

Perfect for camping: enamel plate

- Sturdy and nearly unbreakable
- Comes in different colours



Colour	Sky Blue / Cream
Measurements	24,5 cm
Net weight	270 g
Material	Enemal coated steel
Item no.	10421006



MADAM BLÅ SAUCEPAN

Practical saucepan

- Can be used on open fire
- Handle hole allows for hanging storage
- Designed to pour directly from the pan



Colour	Sky Blue / Cream
Measurements	15 x 8 cm
Capacity	900 ml
Net weight	318 g
Material	Enemal coated steel
Item no.	10421001



MADAM BLÅ MEASURE CUP

Multi-functional and sturdy measure cup in a timeless design

- Practical cup to measure liquids in the outdoors
- Can be used as a bowl
- Convenient handle



Colour	Sky Blue / Cream
Measurements	12 x 4 cm
Capacity	250 ml
Net weight	110 g
Material	Enemal coated steel
Item no.	10421002

MADAM BLÅ CUP

The classic enamel cup ensures a sense of nostalgia

- Gives the real outdoor feeling
- Comes in different sizes and colours
- Sturdy handle and rounded drinking rim



	Madam Blå Cup Small	Madam Blå Cup Large
Colour	Sky Blue / Cream	Sky Blue / Cream
Measurements	7 x 7 cm	8 x 9 cm
Capacity	250 ml	350 ml
Net weight	110 g	140 g
Material	Enemal coated steel	Enemal coated steel
Item no.	10421003	10421004





Titanium Cutlery Set of 3
45 g without carabiner
Item no. 119021



Titanium Cutlery Set of 2
28 g without carabiner
Item no. 119020



Titanium Spoon XL
20 g. Item no. 119029

Cutlery & Cookware



Titanium Fork, Foldable
14 g. Item no. 119026



Titanium Spoon, Foldable
19 g. Item no. 119027



Titanium Knife, Foldable
15 g. Item no. 119028



Titanium Mug
220 ml, 70 g, Item no. 119010
450 ml, 115 g, Item no. 119011



Titanium Spork, Foldable
17.5 g. Item no. 119025



Titanium Plate
500 ml, 66 g
Item no. 119024



**AMBI
TION**

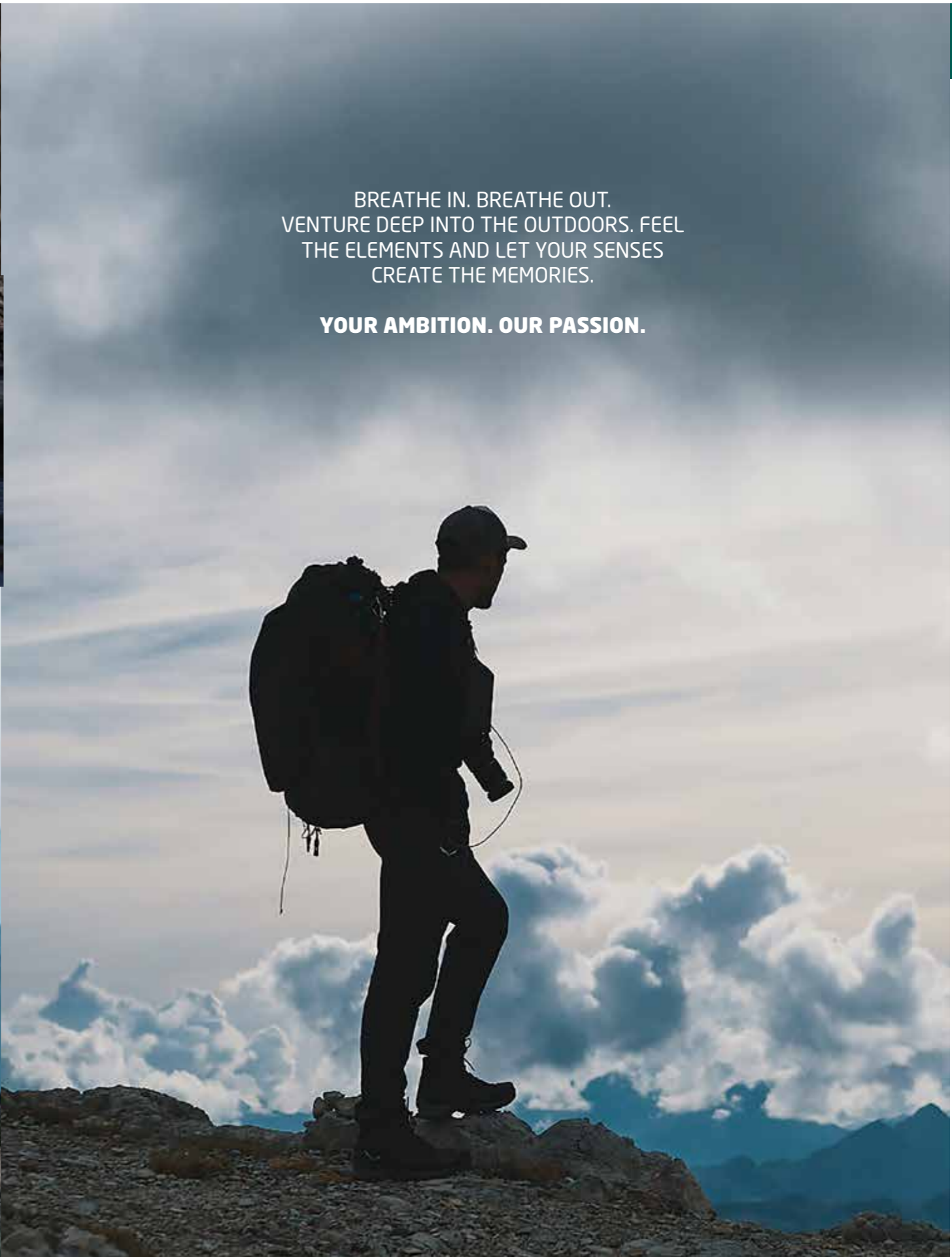

BREATHE IN. BREATHE OUT.
VENTURE DEEP INTO THE OUTDOORS. FEEL
THE ELEMENTS AND LET YOUR SENSES
CREATE THE MEMORIES.

YOUR AMBITION. OUR PASSION.

Dreams
Explore
Purpose
Dare
Aching
Moments
Memories



AMBI TION

Tents

Svalbard, Halland.....	84
Meet Oppland 4	86
Level-Opp	88
Telemark 2.2 PU, Otra 2 PU	90

Tarps

Voss, Voss Tentwing.....	92
--------------------------	----

Bushcraft

Jorund, Troms, Voss Tech	94
--------------------------------	----

Sleeping Bags

Puk.....	98
Gormsson	100
Passion, Balance.....	104
V.I.B.....	106

Mats

Vega, Vanna	108
-------------------	-----

Bags and Packs

Flakstad, Skara, Packing Cube Set.....	110
--	-----

Made for more!

You need to trust your tent like an old friend, like a true adventure buddy. So look for the qualities you would look for in a friend: sturdy, reliable and tough as nails. **Choose a tent that will never let you down.**



SVALBARD 1 PU

Sturdy tent that will never let you down

- Passed windtest for hurricane winds (40.0 m/sec)
- If the weather is too hot, then you can pitch the inner tent as a stand alone
- We have engineered the pole construction for true sit-up height
- New rip-stop fabric for extra tensile strength

Colour	Dark Olive
Material flysheet	100% Polyester, Rip-stop, PU
Net weight	2.200 g
Pack size	12 x 50 cm
Item no.	122059



SVALBARD 1 SI

Very light and packs small but performs big

- Passed windtest for hurricane winds (40.0 m/sec)
- If the weather is too hot, then you can pitch the inner tent as a stand alone
- 100% Nylon and very light

Colour	Forest Green
Material flysheet	100% Nylon, Rip-stop, 40D
Net weight	1.750 g
Pack size	15 x 45 cm
Item no.	112027

Extend the lifetime of your tent by using a footprint

You have been hiking all day, seeing nature from it's most beautiful side, and now you have found the perfect spot for your campground. This is the place where you want to camp, sleep and wake up with a freshly brewed cup of coffee while you watch the sunrise - priceless! The Halland tent has everything you need for two people - or just extra space if you are on your own journey.



HALLAND 2 PU

An aerodynamic tunnel tent with everything you need for two people

- Easy and quick to pitch - and to pack down again
- The tunnel shaped construction provides great wind stability
- Enjoy the view of the outdoors directly from your sleeping cabin through the front opening
- New rip-stop fabric for extra tensile strength

Colour	Dark Olive
Material flysheet	100% Polyester, Rip-stop, PU
Net weight	3.150 g
Pack size	15 x 50 cm
Item no.	122062

MEET OPPLAND 4

- the new member of the Oppland family!
Our most spacious trekking tent yet.

Made for the adventurous family, the crew or the group of friends that demand a proper camp, appreciate numerous features and rely on the low weight.



Extend the lifetime of your tent by using a footprint

Built for nature! Make sure to have your outdoor essentials right everytime. The Oppland tents exceed every need and simply want to be part of your adventures. These tents are brilliant on the trail and shine in camp. Go explore.
Go Nordisk. Go Oppland.

NEW
OPPLAND 4

OPPLAND 2/3/4 PU

Plenty of room for storage and cooking.
What's not to like!

- Very spacious apsis
- Multiple options for ventilations ensuring great indoor climate
- Sturdy tunnel tent with high wind stability
- New rip-stop fabric for extra tensile strength



	Oppland 2 PU	Oppland 3 PU	Oppland 4 PU
Colour	Dark Olive	Dark Olive	Dark Olive
Material flysheet	100% Polyester, Rip-stop, PU	100% Polyester, Rip-stop, PU	100% Polyester, Rip-stop, PU
Net weight	3.600 g	4.200 g	4.650 g
Pack size	20 x 50 cm	20 x 55 cm	20 x 55 cm
Item no.	122076	122077	122078

OPPLAND 2/3 SI

Sturdy, spacious with superb sleeping environment

- Sturdy tunnel tent with high wind stability
- Very spacious apsis
- Multiple options for ventilations ensuring great indoor climate
- Siliconized lightweight nylon fabric



	Oppland 2 SI	Oppland 3 SI
Colour	Forest Green	Forest Green
Material flysheet	100% Nylon, Rip-stop, 40D	100% Nylon, Rip-stop, 40D
Net weight	2.900 g	3.550 g
Pack size	15 x 50 cm	20 x 50 cm
Item no.	112032	112033

Level-Opp

OPPLAND 2/3/4

The best-in-class tunnel tent has taken a quantum leap forward with a complete redesign.

Last year, we improved the PU fabric. This season, we improved everything else. The Oppland PU is no longer just the beginner's choice - it is a true force to be reckoned with.

More spacious. Closer to nature. Easier to pitch.



Inside:

- Simplified connections between inner tent and flysheet.
- Bigger opening and mirroring of the zipper in the inner tent makes it easier to unload your gear quickly.
- We have increased the height and improved the tension of the inner tent to avoid wet sleeping bags due to contact with the fabric.
- New pockets added to the inner cabin to improve storage space.
- Ceiling cords in the cabin allow you to dry clothes or attach a mesh shelf for additional storage space.
- Additional ventilation in the inner cabin, which can be adjusted from the inside. (Only Oppland 4 PU)

AMBI
TION

Outside:

- New Architecture. We changed the pole angles to maximize space and for you to add a couple of friends to the cardgame.
- Making the door higher gives you a better entrance and a much better look at nature outside.
- By introducing polesocks, the tent can be pitched with ease by one person from one side.
- Improved pole tensioning system makes your tent stand better than ever.
- HUGE and flexible apsis entrance that adapts to any situation.
 - × Normal Opening
 - × Large Opening
 - × Partial Opening
 - × Porch Tarp Mode
- Side-entrance is bigger and higher, so you can see both in and out when crouching.
- Improved groundventilation with articulated flysheet cut.
- Tarp Ready. Integrated tarp loops on entrance to easily create an extra outdoor living space with a Nordisk Voss Tentwing tarp.



INVITE THE OUTDOORS IN!

This is pretty much an open-ended invitation to let nature join you closely wherever you go. Otra's all-mesh cabin provides a remarkable inner climate and fantastic ventilation, supported by the option to open all 4 sides of the flysheet for uninterrupted airflow and a 360 degree view of the nature around you.

Your senses will tingle, and your mind will be thanking you.

How adventurous are you?

With the introduction of our new Telemark 2.2 PU, the Telemark tent series will not only appeal to the Ultra Lightweight-focused people. Now, the ambitious adventurers will have the opportunity to get that Telemark experience, exploring the great outdoors. This technical and double layer 2-person tent still offers low weight and great durability - with a double entrance.

**So the question remains;
How adventurous are you?**

2 doors allow you to enter or exit the tent without waking each other up at night.



TELEMARK 2.2 PU

Introducing the iconic Telemark with double entrance in a new fabric

- Apsis with room for luggage or cooking
- Great ventilation for good indoor environment
- Outer doors can be turned into a canopy
- New rip-stop fabric for extra tensile strength

	Dark Olive
Material flysheet	100% Polyester, Rip-stop, PU
Net weight	1.900 g + bonus pack
Pack size	15 x 44 cm
Item no.	122058

Bonus pack included:
2 extra guy lines, 3 extra pegs, 2 canopy poles



OTRA 2 PU

Its geodesic architecture and its 90° upright walls at the foot and head create a great sensation of space, allowing you to really utilize the floor area. Even though it is only a 2 person tent, it will easily fit four people playing a game of cards with comfortable sitting height for everyone.

Making sure it will suit you in every possible situation, it can even be pitched either as a standalone flysheet or a standalone cabin, adding to Otra's already incredibly versatile feature list.

**We have already handed out the invitation.
You just have to step out to accept it.**

- Apsis on both sides for extra storage or cooking space
- Dome construction with double entry, high stability and great space utilization
- Zipper opening on all four sides for 360° panoramic view
- 3-in-1-pitch - can be set up as double layer tent, flysheet only or inner tent only
- Ceiling storage net for phone, wallet, flashlight etc.
- New rip-stop fabric for extra tensile strength

	Dark Olive
Material flysheet	100% Polyester, Rip-stop, PU
Net weight	4.350 g
Pack size	18 x 53 cm
Item no.	122063

Level up! Epic endeavors call for products you can trust. Our Nordisk tarps are all geared up and ready to take your outdoor-game to the next level! Use as a stand-alone or give your tent superpowers.



VOSS PU

The versatile Voss tarp offers good durability and flexible use

- Multiple attachment points and numerous setup options
- Small pack size
- Use as stand-alone or connect to your Nordisk tent
- New rip-stop fabric for extra tensile strength

	Voss 9 m ² PU	Voss 14 m ² PU	Voss 20 m ² PU
Colour	Dark Olive	Dark Olive	Dark Olive
Material flysheet	100% Polyester, Rip-stop, PU	100% Polyester, Rip-stop, PU	100% Polyester, Rip-stop, PU
Net weight	1.050 g	1.500 g	2.050 g
Pack size	20 x 33 cm	20 x 33 cm	24 x 33 cm
Item no.	127019	127020	127021



VOSS TENTWING PU

Tailored protection against dew, rain and sun

- Multiple attachment points and numerous setup options
- Designed for tents with a front door or use as stand-alone
- Small pack size
- New rip-stop fabric for extra tensile strength

Colour	Dark Olive
Material flysheet	100% Polyester, Rip-stop, PU
Net weight	700 g
Pack size	22 x 35 cm
Item no.	127022



VOSS SI

The lightweight Voss tarp offers multiple setup possibilities and low pack size

- Multiple attachment points and numerous setup options
- Small pack size and lightweight tarp
- Use as stand-alone or connect to your Nordisk tent

	Voss 9 m ² SI	Voss 14 m ² SI	Voss 20 m ² SI
Colour	Forest Green	Forest Green	Forest Green
Material flysheet	100% Nylon, Rip-stop	100% Nylon, Rip-stop	100% Nylon, Rip-stop
Net weight	800 g	1.100 g	1.550 g
Pack size	22 x 30 cm	22 x 30 cm	28 x 34 cm
Item no.	117011	117012	117013



VOSS TENTWING SI

Designed for a great fit to tunnel tents - or use as stand-alone

- Multiple attachment points and numerous setup options
- Designed for tents with a front door or use as stand-alone
- Very small pack size

Colour	Forest Green
Material flysheet	100% Nylon, Rip-stop
Net weight	500 g
Pack size	24 x 36 cm
Item no.	117014



Release your inner bushcrafter and let your true adventure begin

We have simply perfected these products to become your best buddies in any situation - especially when nature shows its true self.

**No nonsense. No compromise.
This is the closest you get to nature.**



JORUND TECH BIVY

If you can only bring one piece of hardware - this is it!

- Waterproof and highly breathable shell fabric, insulated with polyester microfilling
- Useable as: Sleeping bag, poncho, tarp, underquilt, blanket - get inspired on the next page
- Built-in hood for poncho or sleeping bag
- Heat-reflecting TPU membrane

Colour	Forest Night /Black
Measurements	160 x 270 cm
Material shell	100% Nylon, 10000 mm WP/MP
Material lining	Polyester soft lining
Filling	Polyester micro filling
Net weight	1.210 g
Pack size	16 x 25 cm
Item no.	106000

TROMS MESH CABIN

This innovative product lets you enjoy your adventures in complete freedom. It allows you to get that open-air feeling but still protects you from bugs, wind and wet soil.

- Pitches with either trekking poles, branches or made-to-fit aluminium poles (sold separately)
- 40 cm windbreaker walls below the mesh
- Entrance from side or end
- Designed to fit under any Nordisk Voss tarp if the elements should turn against you

Persons	2
Colour	Dark Moss / Black
Measurements	220 x 135 x 100 cm
Material	100% Nylon
Net weight	1.200 g
Pack size	15 x 35 cm
Guy lines	1,5 mm Dyneema
Poles	Aluminium - 2 pieces
Pegs	Aluminium Twister pegs - 6 pieces
Item no.	117016



VOSS TECH

We like to refer to our Voss Tech as the swiss army knife of shelters, giving a massive boost to your bushcrafter-ego.

- An all-in-one solution to any sheltering need in the wilderness
- Multiple-purpose tarp with many attachment points - get inspired on the next page
- Extremely durable - tested to carry more than 250 kg as a hammock.

Bonus pack included

Colour	Dark Moss
Measurements	260 x 220 cm
Material	100% Nylon, Rip-stop, 68D
Water Column	2000 mm
Net weight	1.100 g + bonus pack
Pack size	15 x 20 x 8 cm
Item no.	127023

Bonus pack included: 4 pcs webbing slings, 2 pcs XL hooks, 2 pcs hammock slings, 1 pcs Pack Sack





JORUND TECH BIVY

Is it a tarp? Is it a poncho? No, it's a sleeping bag. Well, actually, it's all in one - and so much more!

Jorund Tech Bivy is a real allrounder with endless possibilities for the true outdoor lover.



Jorund Tech Bivy is the perfect bivy bag. Not only will it keep you dry. Thanks to the innovative heat reflecting shell and insulating fibre filling, it keeps you warm on its own or boosts your favorite sleeping bag.



The bivy transforms into an insulated rain poncho when needed. The sewed-in zippers and concealed hood provide a comfortable fitting and the breathable shell gives you the necessary air exchange. On top of this, the special material reflects the body heat in low temperatures.



The rectangular form makes a great tarp to protect you or your essentials from the elements. The included lines are useful for a number of pitching variations.

Thanks to the the shape and many webbing loops, the Jorund Tech Bivy can even transform into an insulating underquilt.



The Jorund Tech Bivy can also be used to build a lightning fast shelter. Use logs, branches or trekking poles to pitch it in a true bushcrafting manner!



The Jorund Tech Bivy is a true allrounder with a small pack size and a low weight. It can be used for a multitude of purposes and thanks to its sturdy material, it is extremely durable.



19 webbing loops give nearly endless possibilities of how to set up the Voss Tech to provide shelter from rain, wind or sun.

VOSS TECH

AMBI
TION

We like to refer to the Voss Tech as the Swiss Army knife of shelters - use it as a tarp, a hammock, an emergency stretcher, a tent or poncho. A must-have for every bushcrafter.



The Voss tech can be used as a rain poncho which also covers your backpack. And if you are in the mood for a rest, just build yourself a solid hammock with a roof. It is easy to set up and the sturdy material can hold up to 150 kilo as a single layer hammock and up to 250 kilo as a double layer hammock.



Lightweight, small pack size, endless possibilities: the Voss Tech fits easily in every backpack and can be used for different purposes.



When you need a quick shelter from the elements, the Voss Tech can be pitched as a mini tent within minutes, using a branch or a trekking pole as your centre pole. The waterproof zipper provides an easy entrance and exit.



Puk is designed to be your reliable and high-performance sleeping bag. With all the features and technical details of its high-end siblings, it stands out as a surprisingly great purchase.

Go Explore. Go Nordisk. Go Puk.

PUK +10° Curve

This sleeping bag is the perfect companion for warmer climates

- Designed with a spacious footbox
- Internal chest pocket keeps the personal items safe
- A wide contoured hood makes the bag versatile for use even if weather cools down



Colour	True Navy / Mustard Yellow / Black
Sizes	M-L-XL
Shape	Curve
Shell material	100% Polyester, 20D
Lining material	100% Nylon, 30D
Filling	Norguard S-PO 80
Net weight	550-650 g
Temperature	+15° +10° -2°



PUK -2° Curve

3-season sleeping bag for optimal comfort

- Designed with an internal thermal collar
- Internal chest pocket keeps the personal items safe
- A wide contoured hood makes the bag versatile for use even if weather cools down



Colour	True Navy / Mustard Yellow / Black
Sizes	M-L-XL
Shape	Curve
Shell material	100% Polyester, 20D
Lining material	100% Nylon, 30D
Filling	Norguard S-PO 80
Net weight	1.200-1.400 g
Temperature	+5° -2° -18°



PUK -10° Mummy

Cozy winter sleeping bag

- Designed with an internal thermal collar and internal chest pocket
- A lightweight and tough Polyester Rip-stop shell makes the bag durable
- Mummy shape with contour hood and spacious footbox



Colour	True Navy / Mustard Yellow / Black
Sizes	M-L-XL
Shape	Mummy
Shell material	100% Polyester, Rip-stop, 20D
Lining material	100% Nylon, 30D
Filling	Norguard S-PO 80
Weight	1.640-2.250 g
Temperature	-5° -10° -20°



GORMSSON +10° Curve

Optimal high summer performance bag

- Curve shape with 3D hood and spacious Shark-fin foot box
- A lightweight Nylon Rip-stop shell and Soft Touch lining
- Internal chest pocket keeps the personal items safe



Colour	Artichoke Green / Mustard Yellow / Black
Sizes	M-L-XL
Shape	Curve
Shell material	100 Nylon, 20D, Rip-stop
Lining material	100 Nylon, 30D
Filling	Norguard S-PO 85
Net weight	500-600 g
Temperature	+14° +10° -2°



GORMSSON +4° Curve

Summer bag contoured to enhance your performance

- Designed with a secondary shoulder zipper
- Curve shape with 3D hood and spacious Shark-fin foot box
- A lightweight Nylon Rip-stop shell and Soft Touch lining



Colour	Artichoke Green / Mustard Yellow / Black
Sizes	M-L-XL
Shape	Curve
Shell material	100 Nylon, Rip-stop, 20D
Lining material	100 Nylon, 30D
Filling	Norguard S-PO 85
Net weight	650-750 g
Temperature	+9° +4° -10°



GORMSSON -2°

3-season contoured sleeping bags for optimal performance

- Comes in a Egg, Mummy and Curve shape
- A lightweight Nylon Rip-stop shell and Soft Touch lining
- Designed with a 2-way side zip
- Curve shape with 3D hood and spacious Shark-fin foot box with extra ventilation
- Secondary shoulder zipper



Colour	Artichoke Green / Mustard Yellow / Black
Sizes	M-L-XL (Curve, Egg) S-M-L-XL (Mummy)
Shape	Curve, Egg, Mummy
Shell material	100 Nylon, Rip-stop, 20D
Lining material	100 Nylon, 30D
Filling	Norguard S-PO 85
Net weight	1.050-1.450 g
Temperature	-4° -2° -20°



The Nordisk Gormsson series is your excuse to sleep outside every night. Every Gormsson is a top-performing bag, balancing weight and price tag perfectly on a knife's blade and is bound to become your go-to choice for years and years of exploring.



Don't let the cold weather get in your way

Release your inner explorer and let your winter adventure begin. These sleeping bags will keep you warm and happy when the temperature drops way below zero.



GORMSSON -10° Mummy

A next generation and well-tried performance winter bag

- Mummy shape with 3D hood and spacious Shark-fin foot box with extra ventilation
- A lightweight Nylon Rip-stop shell and Soft Touch lining
- Designed with the off-set double box chamber construction
- Secondary shoulder zipper



Colour	Artichoke Green / Mustard Yellow / Black
Sizes	M-L-XL
Shape	Mummy
Shell material	100 Nylon, Rip-stop, 20D
Lining material	100 Nylon, 30D
Filling	Norguard S-PO 85
Net weight	1.650-1.850 g
Temperature	-6° -10° -30°

GORMSSON -20° Mummy

The Gormsson -20 is made for extreme use

- A lightweight Nylon Rip-stop shell and Soft Touch lining
- Designed with the off-set double box chamber construction
- Mummy shape with 3D hood and spacious Shark-fin foot box with extra ventilation
- Secondary shoulder zipper



Colour	Artichoke Green / Mustard Yellow / Black
Sizes	M-L-XL
Shape	Mummy
Shell material	100 Nylon, Rip-stop, 20D
Lining material	100 Nylon, 30D
Filling	Norguard S-PO 85
Net weight	2.030-2.380 g
Temperature	-10° -20° -40°



Ultra lightweight award eater

We have put all our knowledge and passion into making this ultimate down-filled sleeping bag, and you won't believe your senses. It's like wrapping yourself in pure warm air.



PASSION ONE

Premium ultra lightweight summer bag

- Extremely soft and comfortable
- Highly breathable outer casing made from an ultralight rip-stop
- Ultra small pack size
- Only 280g

Colour	Mood Indigo / Black
Sizes	M-L-XL
Shape	Mummy
Material	Next to nothing® Ultralight rip-stop nylon
Filling	Crystal Down® 95/5 800+ European white goose down 800+ cuin (EU) / 870+ cuin (US)
Net weight	300-350 g
Temperature	+15° +12° -1°

PASSION THREE/FIVE

Premium ultra lightweight sleeping bag

- Keeping weight and pack size at a minimum
- Zipper baffle
- Iso collar (only Passion Five)

Colour	Mood Indigo / Black
Sizes	M-L-XL
Shape	Mummy
Material	Next to nothing® Ultralight rip-stop nylon
Filling	Crystal Down® 95/5 800+ European white goose down 800+ cuin (EU) / 870+ cuin (US)
Net weight	500-850 g
Temperature	+7° +3° -10° / -2° -7° -25°



The vertical chambers of the Balance distribute the warmth from your body to your feet where you need it the most.

Your guarantee for a perfect night's sleep.



BALANCE 400/600

Clever heat distributing sleeping bag

- Quick and evenly heat distribution
- FlowGate eliminates down movement
- Adjustable neck baffle and draft collar
- Zipper baffle

Colour	Forest Night / Green Moss
Sizes	M-L-XL
Shape	Mummy
Material	Recycled rip-stop nylon
Filling	Crystal Down® Dry 90/10 700+ European water-repellent down 700+ cuin (EU) / 760+ cuin (US)
Net weight	800-1.150 g
Temperature	+3° -3° -19° / -2° -8° -26°

AMBI
TION



Perfect lightweight comfort for all seasons

V.I.B. is a long and trusted friend for anyone who has ever tried it. The V.I.B. range covers all temperatures of the four seasons. From summer holidays in the hut up to the expedition in the Arctic.



V.I.B. 250

- Highly breathable fabric
- Adjustable neck baffle to maintain the heat inside your sleeping bag

Colour	Black / Fiery Red
Sizes	M-L-XL
Shape	Mummy
Shell material	Lightweight rip-stop nylon
Lining material	Lightweight nylon
Filling	Crystal Down® 95/5 750+ European white goose down 750+ cuin (EU) / 820+ cuin (US)
Net weight	600-700 g
Temperature	+10° +6° -8°



AMBI
TION

V.I.B. 400/600

- Highly breathable fabric
- Adjustable neck baffle to maintain the heat inside your sleeping bag
- Iso collar

Colour	Black / Fiery Red
Sizes	M-L-XL
Shape	Mummy
Shell material	Lightweight rip-stop nylon
Lining material	Lightweight nylon
Filling	Crystal Down® 95/5 750+ European white goose down 750+ cuin (EU) / 820+ cuin (US)
Net weight	800-1.150 g
Temperature	+3° -2° -18° / 0° -5° -22°



V.I.B. 800

- Highly breathable fabric
- Adjustable neck baffle to maintain the heat inside your sleeping bag
- Iso collar
- Freezing puff
- Integrated Z-layer footbox

Colour	Black / Fiery Red
Sizes	M-L-XL
Shape	Mummy
Shell material	Lightweight rip-stop nylon
Lining material	Lightweight nylon
Filling	Crystal Down® 95/5 750+ European white goose down 750+ cuin (EU) / 820+ cuin (US)
Net weight	1.150-1.400 g
Temperature	-6° -13° -32°





It is important to get a good night's rest if you're spending a few nights in the outdoors. These Nordisk sleeping mats are designed to turn you into Sleeping Beauty. You simply get it all with these mats: **Comfort, durability and light weight.**



VEGA

Vega is a small packed soft sleeping mat

- Horizontal baffle construction for excellent comfort
- Lightweight sleeping mat
- Square shaped sleeping area and very stable design
- Designed with a strong 20D Honeycomb shell for a more durable surface

Material front	100% Polyester, 20D
Material back	100% Polyester, 30D, anti-slip
Net weight	460 g
Colour	Burnt Red / Black
Item no.	115005



VANNA 2.5 / 3.8

**For when you want it all:
Lightweight, self-inflating and comfortable**

- Lightweight self-inflating foam mat with hybrid foam zone construction
- Mummy shaped design
- Great cushioning and durability

Material front	100% Polyester, 20D
Material back	100% Polyester, 20D
Net weight	400 -540 g
R-Value	2.3 / 3.6
Colour	Burnt Red / Black
Item no.	Vanna 2.5 / 115003 - Vanna 3.8 / 115004

All geared up for the next adventure!

Are you an outdoor addict? And do you often travel to explore new adventures? Take these incredibly durable bags with you anywhere - designed to endure!

SKARA 70/100 GEARBAG

The ultimate gear bag for rough adventures

- Waterproof bottom and water repellent outer fabrics
- Double webbing haul handle at both ends
- Carry handles offer flexible positioning
- Detachable backstraps
- Packing re-usable as practical packing cubes



	Skara 70 Gear Bag	Skara 100 Gear Bag
Colour	Forest Green / Burnt Red	Forest Green / Burnt Red
Vol.	70 L	100 L
Measurements	66 x 35 x 31 cm	79 x 38 x 34 cm
Material	100% Polyester	100% Polyester
Net weight	1.260 g + Packing Cube 100 g	1.450 g + Packing Cube 100 g
Item no.	133086 / Forest Green 133087 / Burnt Red	133088 / Forest Green 133089 / Burnt Red



PACKING CUBE SET SMALL/LARGE

Packing made easy - a 3-piece organiser set

- Fits perfectly into the Skara gear bag
- Designed with a webbing carry handle at top
- Stretchable mesh for increased packing flexibility
- Lightweight



Colour	Magnet
Vol.	Small 3,5 L Large 7 L
Measurements	Small 17,5 x 24,5 x 8 Large 35 x 24,5 x 8 cm
Material	100% Polyester
Net weight	Small 60 g Large 100 g
Item no.	133105



FLAKSTAD 45/65/85 TRAVEL BAG

Versatile travel bag for exploring or everyday use

- Packing is made easy with a large main opening
- Designed with a cross-shoulder strap and backstraps with padded shoulder support
- Double webbing haul handle at both ends



	Flakstad 45 Travel Bag	Flakstad 65 Travel Bag	Flakstad 85 Travel Bag
Colour	Magnet / Burnt Red	Magnet / Burnt Red	Magnet / Burnt Red
Vol.	45+5 L	65+5 L	85+5 L
Measurements	55 x 39 x 39 cm	65 x 32 x 32 cm	75 x 34 x 34 cm
Material	100% Polyester	100% Polyester	100% Polyester
Net weight	1.060 g	1.240 g	1.390 g
Item no.	133090 / Magnet 133091 / Burnt Red	133092 / Magnet 133093 / Burnt Red	133094 / Magnet 133095 / Burnt Red



**DURIN
SPACEMAKER SET**
Set of 3 bags
Item no. 103001





**AD
DIC
TION**



GO DEEP. GO FAR.
DON'T LET ANYTHING GET IN YOUR WAY.
HUNGER, PAIN AND FATIGUE CAN BE BEATEN
BY MENTAL AND PHYSICAL STRENGTH.
ELEMENTS WILL BE CONQUERED. NO EXCUSES.

YOUR ADDICTION. OUR PASSION.



Pain
Hunger
Thrill
Pulse
Force
No compromise
Expedition



AD DIC TION

Tents and Tarps

Voss 2, 5, 7 LW.....	116
Lofoten ULW	117
Telemark LW - 10 year anniversary.....	119
Halland LW, Oppland LW.....	120

Sleeping Bags

Arctic.....	122
Fever Ultra	124
Phantom	121
Oscar	126

Mats

Ven, Grip	129
-----------------	-----



Worlds lightest fully-functional tarp. No nonsense. No compromise. No doubt.



Ridiculously small. Unbelievably light.

The further you have to go, the more you will love yourself for bringing the Lofoten along. We designed this award winning ultra lightweight race tent to meet the demands for a reliable shelter that you can pitch in an instant, carry without noticing and pack in the bottle pockets on your race vest.

The Lofoten ULW is not made to be big. It is made to be fast. So, are you willing to sacrifice extra space for extra pace?



VOSS 2 LW

Lightweight tarp for quick fix or as a tentwing for Nordisk Lofoten and Telemark tents.

- Extreme small pack size and lightweight. The flysheet weight is only 80 grams.
- Fully functional tarp with 5 attachment points.
- Including 4 fast-attach guy lines, each with guy line slide and Mini Hook.
- Compatible tentwing for the LW tent range.

	VOSS 2 LW
Colour	Forest Green
Material flysheet	100% Nylon, Rip-stop
Measurements	184 x 230 cm
Net weight	100 g / 130 g incl. 2 guy lines / 140 g incl. all 4 guy lines
Pack size	15 x 15 cm
Item no.	117023

VOSS 5 LW

Lightweight tarp for 1 person or as an add-on to the Nordisk LW tent Range.

- Extreme small pack size and lightweight. The flysheet weight is only 170 grams.
- Fully functional tarp with 8 attachment points.
- Including 6 fast-attach guy lines, each with guy line slide and Mini Hook.
- Compatible with the LW Tent range.

	VOSS 5 LW
Colour	Forest Green
Material flysheet	100% Nylon, Rip-stop
Measurements	18 x 10 cm
Net weight	170 g / 190 g incl. 2 guy lines / 240 g incl. all 6 guy lines
Pack size	15 x 20 cm
Item no.	117015

VOSS 7 LW

Lightweight 2 persons multi functional tarp.

- Extreme small pack size and lightweight. The flysheet weight is only 280 grams.
- Fully functional tarp with 12 attachment points.
- Including 6 fast-attach guy lines, each with guy line slide and Mini Hook.
- Can be put up as a ridge tarp, open shelter, tent or as a closed end hammock tarp.
- Compatible with the LW Tent range.

	VOSS 7 LW
Colour	Forest Green
Material flysheet	100% Nylon, Rip-stop
Measurements	380 x 220 cm
Net weight	250 g / 280 g incl. 2 guy lines / 330 g incl all 6 guy lines.
Pack size	15 x 25 cm
Item no.	117022



LOFOTEN 1 & 2 ULW

The world's lightest 1 and 2 person tents

- Trim weight 520 g / 540g
- World's smallest pack size
- Quick and easy to pitch

Bonus pack included

	Lofoten 1 ULW	Lofoten 2 ULW
Colour	Forest Green / Burnt Red	Forest Green / Burnt Red
Material flysheet	100% Nylon, Rip-stop, 7D	100% Nylon, Rip-stop, 7D
Trim weight	520 g	540 g
Net weight	560 g	590 g
Pack size	11 x 22 cm	11 x 22 cm
Item no.	151017 / Forest Green 151018 / Burnt Red	151020 / Forest Green 151021 / Burnt Red

Trim weight: Excl. packsacks, footend pole and bonus pack. Regular weight: All included except the bonus pack.

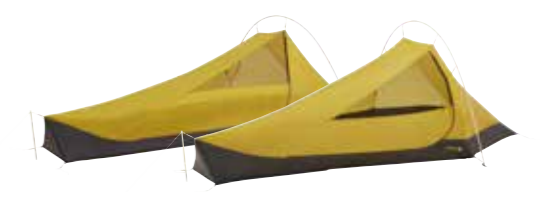

LOFOTEN EXTRA CABINS

The Lofoten flysheet is identical for the 2 versions, so by changing the cabin you can have either more space in the cabin or more space in the apsis. Available as an additional purchase.

FOR RACING WITHOUT COMPROMISE

This year, we celebrate the 10 year anniversary of the original Nordisk Telemark

A tent so light that you can bring it anywhere, so small that you can always fit it into your bag, and so spacious that you can stay, sit and sleep effortlessly while keeping your belongings dry too.

You can even prepare your racefood under the door if you need to. This is the ideal combination of weight reduction, comfort and performance (and a bucket load of awards...).

The Original.

Often imitated, never duplicated.

#10YearsOfTelemark



TELEMARK 2.0 LW 10 Year Anniversary Edition

TELEMARK 2.0 LW	
Colour	Whisper White
Material flysheet	100% Nylon, Rip-stop, 10D
Trim weight	920 g
Net weight	1000 g
Pack size	12 x 41 cm
Item no.	10921040
Bonus pack included: 2 extra guy lines, 3 extra pegs	

TELEMARK LW

Superlight and spacious race tent

- Adjustable cabin width
- Apsis with room for luggage or cooking
- Great ventilation for better inside climate



reddot design award
winner 2013

	Telemark 1 LW	Telemark 2 LW
Colour	Forest Green / Burnt red	Forest Green / Burnt red
Material flysheet	100% Nylon, Rip-stop, 10D	100% Nylon, Rip-stop, 10D
Trim weight	720 g	790 g
Net weight	890 g	1000 g
Pack size	12 x 41 cm	12 x 41 cm
Item no.	151010 / Forest Green 151012 / Burnt Red	151006 / Forest Green 151008 / Burnt Red
Bonus pack included: 2 extra guy lines, 3 extra pegs		

TELEMARK 2.2 LW

The team racing favorite

- 2 doors allow you to enter or exit the tent without waking each other up at night
- Adjustable cabin width
- Apsis with room for luggage or cooking
- Great ventilation



Colour	Forest Green / Burnt red
Material flysheet	100% Nylon, Rip-stop, 10D
Trim weight	1.000 g
Net weight	1.080 g
Pack size	13 x 41 cm
Item no.	151024 / Forest Green 151025 / Burnt Red
Bonus pack included: 2 extra guy lines, 3 extra pegs	



The trekker's choice

When you are away for more than just a few days, there is such a thing as too lightweight.



So we have designed these two lightweight wonders that offer a surprising amount of space for bags, shoes and cooking, but weigh less than your Pocket stove and three tins of tomatoes.

And it will take a serious storm to knock them over!

HALLAND 2 LW

Go superlight, superstrong and keep your belongings dry

- Small apsis for shoes, bags etc.
- Outer pitched so it can be used as a standalone shelter
- This trekkers choice weighs only 1.360 g



	
Colour	Forest Green / Burnt Red
Material flysheet	100% Nylon, Rip-stop, 10D
Trim weight	1.360 g
Net weight	1.440 g
Pack size	14 x 35 cm
Item no.	151015 / Forest Green 151016 / Burnt Red



OPPLAND 2 & 3 LW

Level up with the ultimate lightweight tunnel tent

- Multiple options for ventilations ensuring great indoor climate
- Huge apsis for storage or food/gear preparation
- Sturdy tunnel tent with high wind stability

		
	Oppland 2 LW	Oppland 3 LW
Colour	Forest Green / Burnt Red	Forest Green / Burnt Red
Material flysheet	100% Nylon, Rip-stop, 10D	100% Nylon, Rip-stop, 10D
Trim weight	1.600 g	2.080 g
Net weight	1.700 g	2.090 g
Pack size	13 x 40 cm	13 x 48 cm
Item no.	151022 / Forest Green 151023 / Burnt Red	151013 / Forest Green 151014 / Burnt Red



reddot award 2014
winner



For the true adventurer. A polar expedition is not the place for compromise or false presumptions. The arctic is a no-nonsense sleeping bag that will simply keep you warm and dry. **Promise.**



ARCTIC 1100/1400

Extreme condition down protection

Colour	Coffee / Orange
Sizes	M-L-XL
Shape	Mummy
Shell material	Lightweight Rip-stop Nylon, WP 1200 mm
Lining material	Lightweight Nylon
Filling	Crystal Down®Dry 90/10 700+ European water-repellent down 700+ cuin (EU) / 760+ cuin (US)
Net weight	1.730-2.310 g
Temperature	-10° -18° -38° / -20° -28° -48°
Special feature	120 mm WP all around

Innovation on the shoulder of giants

Making the world's most reliable sleeping bag for extreme conditions is not something you do over night. We have been handcrafting sleeping bags for polar expeditions since 1983, and the Arctic is the tip of the iceberg. Beneath the surface is the knowledge and experience from iconic bags such as the Powerizer and the Fusion that have faithfully served expeditioners through decades of freezing camps in hostile environments.

TAYLORMADE®

Customized for your adventure

Standard models feature -18° and -28° limit temperature ratings which would cover most needs for an ultrawarm sleeping bag. But **if you are going extreme, you can count on us to go with you.** We will adjust the filling to any target temperature you need or even sew it to fit your height, if needed.



Slim down your race weight.
Maximize your storage space.
Simply. Go. Ultra.



FEVER ULTRA

The world's lightest sleeping bag. Period.

- Ultraslim mummy shape to reduce weight and space
- Angle length zipper, 2-way for great ventilation
- Just 245 g (size M)

Colour	Copper / Black
Sizes	M-L-XL
Shape	Mummy
Shell material	Next to nothing® Ultralight rip-stop nylon
Lining material	Rip-stop nylon
Filling	Crystal Down® 95/5 900+ European white goose down 900+ cuin (EU) / 950+ cuin (US)
Net weight	280-310 g
Temperature	+13° +9° -2°
Special feature	Packs like an orange

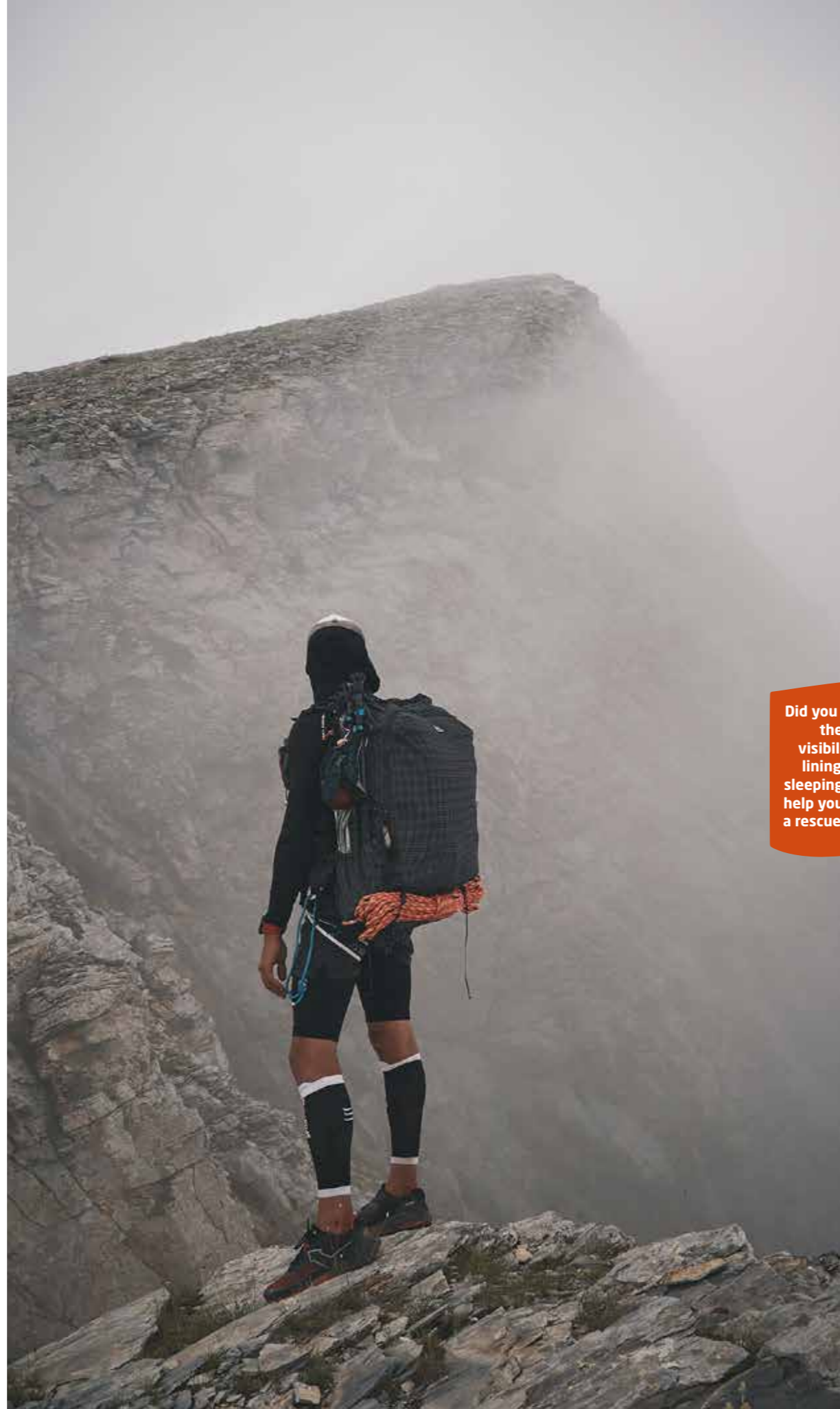

Did you know that the high visibility inner lining of your sleeping bag could help you in case of a rescue situation?

Light as a ghost and shaped to defy physical boundaries.

Phantom is a versatile down sleeping bag that will prove itself a worthy all-year race partner for those who would rather cut some leg room than a hole in their wallet.

ADDITION



PHANTOM 220

Slim fit race bag for fast adventures in the regular season

- Crystal Down Dry repels water and moist
- Inner pocket for valuables
- Angle length zipper, 2-way for great ventilation

Colour	Smoked Pearl / Orange
Sizes	M-L-XL
Shape	Mummy
Shell material	Lightweight rip-stop nylon Black yarn
Lining material	Lightweight nylon
Filling	Crystal Down®Dry 90/10 700+ European water-repellent down 700+ cuin (EU) / 760+ cuin (US)
Net weight	550-660 g
Temperature	+11° +7° -5°
Special feature	Slim fit

PHANTOM 440/770

For year-round adventures, you need a reliable race bag that will perform under all circumstances

- Crystal Down Dry repels water and moist
- Inner pocket for valuables
- Angle length zipper, 2-way for great ventilation

Colour	Smoked Pearl / Orange
Sizes	M-L-XL
Shape	Mummy
Shell material	Lightweight rip-stop nylon Black yarn
Lining material	Lightweight nylon
Filling	Crystal Down®Dry 90/10 700+ European water-repellent down 700+ cuin (EU) / 760+ cuin (US)
Net weight	840-1.410 g
Temperature	+2° -4° -20° / -2° -9° -27°
Special feature	Slim fit

When you seek no compromises and expect conditions to get rough, reach out for your #1 adventure companion. Every detail is constructed to be just what you need and nothing more: Strong ultralight materials, innovative construction and a feature list you won't believe with this weight. And it even comes with 100 % recycled fibre filling.

OSCAR +10°

The ultimate summer racing bag

- The world's lightest fibre bag
- Innovatively shaped, specifically for racing
- Shark fin footbox, allowing your feet to rest in their natural position

	
Colour	Rio Red / Mustard Yellow / Black
Sizes	M-L
Shape	Mummy, Curve
Shell material	100% Nylon, Rip-stop, 7D
Lining material	100% Nylon, Rip-stop, 7D
Filling	Norguard S-PO Eco
Net weight	330-350 g
Temperature	+14° +10° -2°
Special feature	As light as down



OSCAR -2°

3-season adventure monster

- The world's lightest -2° fibre bag
- Innovatively shaped, specifically for racing
- Shark fin footbox, allowing your feet to rest in their natural position

	
Colour	Rio Red / Mustard Yellow / Black
Sizes	M-L-XL
Shape	Curve
Shell material	100% Nylon, Rip-stop, 7D
Lining material	100% Nylon, Rip-stop, 7D
Filling	Norguard S-PO S-Core
Net weight	750-950 g
Temperature	+4° -2° -20°
Special feature	As light as down



OSCAR -10°

Ultralight winter sleeping bag

- Front ventilation zipper
- Tubic construction for vertical heat distribution
- Secondary shoulder zip
- Shark fin footbox, allowing your feet to rest in their natural position

	
Colour	Rio Red / Mustard Yellow / Black
Sizes	M-L-XL
Shape	Mummy
Shell material	100% Nylon, Rip-stop, 20D
Lining material	100% Nylon, Rip-stop, 30D
Filling	Norguard S-PO S-Core
Net weight	1.610-1.850 g
Temperature	-6° -10° -30°
Special feature	As light as down



OSCAR -20°

An extreme bag for extreme conditions

- Front ventilation zipper
- Tubic construction for vertical heat distribution
- Secondary shoulder zip
- Shark fin footbox, allowing your feet to rest in their natural position

	
Colour	Rio Red / Mustard Yellow / Black
Sizes	M-L-XL
Shape	Mummy
Shell material	100% Nylon, Rip-stop, 20D
Lining material	100% Nylon, Rip-stop, 30D
Filling	Norguard S-PO S-Core
Net weight	1.890-2.290 g
Temperature	-10° -20° -40°
Special feature	As light as down





"A foam mat is your reliable partner out there. It offers better insulation than air mats and in case of a puncture (we all know that happens), foam mats will still insulate you against the cold ground."

Daniel Krigslund, outdoor adventurer

Could you just sleep on the ground? Yes, probably.
Would it make you go faster tomorrow? Probably not.

Rest is essential to the ultimate performance, so why would you bring anything but the ultimate equipment?

The Nordisk racing mats are ultralight and extremely packable without compromising insulation and are well worth the space they take up in your backpack. We have cut away all unnecessary weight by shaping the mats to cover only what's necessary.

VEN 2.5

The ultimate weight reduction choice

- Covers the area from head to hip
- Self-inflating and easily deflatable
- Highly durable



Material front	100% Polyester, 20D
Material back	100% Polyester, 20D
Net weight	280 g
R-Value	2.3
Colour	Mustard Yellow / Black
Item no.	115006



GRIP 2.5/3.8

Superlight foam sleeping mat

- Body shaped to reduce weight
- Self-inflating and easily deflatable
- Highly durable
- Extra height for added comfort (Grip 3.8)



Material front	100% Polyester, 20D
Material back	100% Polyester, 20D
Net weight	340 -520 g
R-Value	2.3 / 3.6
Colour	Mustard Yellow / Black
Item no.	Grip 2.5 R / 115007 Grip 2.5 L / 115008 Grip 3.8 R / 115009 Grip 3.8 L / 115010

SOLA 15 DRY BAG

Ultra Lightweight Dry Bag

Keep your belongings dry without compromising your travel weight. Attachable shoulder straps even allow you to swim easily with your essentials safe.

Colour	Forest Green / Burnt Red
Measurements	38 x 25,5 x 15,5 cm
Material	100% Nylon
Net weight	Bag 41 g / Straps 15 g
Vol.	15 L
Item no.	133046 / Forest Green 133047 / Burnt Red



THE 2 KG CAMP

You know that every gram counts if you have to carry it up a mountain. At night. In a blizzard. With someone chasing you, whether it is a wild animal or your closest race rival.

But did you know that Nordisk can supply an entire 2 person camp with less than 2 kilos of weight in your bag? Even with room enough to add some nightcamp Hygge® to keep motivation intact when your body tells you to abort your mission.



Tent, mats, sleeping bags, insulation for 2 persons: less than 2 kilos

Lofoten 2 ULW - 2 person tent	540 g
Fever Ultra down sleeping bag	280 g
Oscar fibre sleeping bag	320 g
Strato men's down jacket	155 g
Alto women's down vest	120 g
Ven 2.5 foam sleeping mat, 2 pcs	560 g
Total weight for 2 persons	1.975 g

Add some extra Hygge®

Brewers Cup coffee & brewer	42 g
Nordisk titanium mug	78 g
Nordisk Polar Bear	32 g
	152 g



See all our "World's lightest" products on theworldslightest.com

NORDISK CARE & REPAIR



HOME OF THE DOWN SPECIALIST

NORDISK CARE & REPAIR



Zolli has been sewing sleeping bags for us for more than 30 years. She knows everything about how to make the perfect sleeping bag!

HANDMADE IN GERMANY FOR ALMOST 40 YEARS

Since 1983, we have been crafting our down filled sleeping bags in Germany, by hand. A rare and proud tradition that would have been easy to abandon by finding cheaper labour and rent elsewhere on the planet. Instead, we chose to do the opposite since high quality matters to us.

In 2020, we invested in a new state-of-the-art facility in Görlitz to carry on this tradition with pride and dedication. By staying close to our customers in Europe, we offer unique services, extraordinary quality and a guarantee that your product is made to last forever. **We fix it all!** Sustainability begins with products that last.

With skilled craftsmanship and modern service facilities placed locally in Europe, we can ensure a fast, reliable and easy service on all products, so you can enjoy nature with a clean conscience.



NORDISK CARE & REPAIR



SUSTAINABILITY BEGINS WITH PRODUCTS THAT LAST!



Prolong your product lifespan

A careful selection of sustainable materials and production processes is only half the journey to a truly sustainable product. Expanding the product lifespan is really the simplest and most obtainable way to ensure our pact with nature. By buying quality products, built to withstand the surroundings you use it in, and designed to last, you can save our precious environment tons of CO₂ emissions.



Repair service

In the unlucky case of breakage or damage to your product, we offer in-house repair service by our highly skilled machinists. Chances are that it may be the same person who made your sleeping bag in the first place. Whether your product has a tear, need a new zipper or simply need a refill of down to restore the fill power, our repair service is a quick and highly qualified solution to your needs.



Wash service

Down products are often chosen because they are naturally light, airy and fluffy. But they can be a bit difficult to handle when it comes to cleaning. Both down and technical fabrics are delicate and require special treatment to maintain its high natural quality.

That is why we offer a unique wash and care service for all our products, making sure they will last a lifetime, for the benefit of your wallet and the Nature we care so deeply for.

NORDISK CARE & REPAIR

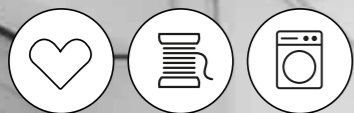

Watch
our video



Die|Manufaktur

In our new Nordisk Care & Repair Centre in Görlitz, Germany, you can meet our passionate staff, some of whom have more than 30 years experience in producing and repairing our premium outdoor products.



Nordisk Care & Repair visitors centre

Do you wish to see how a high quality handmade down sleeping bag is actually made?

Come visit our facility, see and experience this unique process during a tour of our factory. Bring your work team or special guests for a day out or a seminar.

You might think that down is just a great filling for a jacket or sleeping bag to keep you warm, but to us it is a science since there are so many possibilities. It is an adventure that we are very proud to take part in.

Your passion is also our passion.

DOWN VS. FIBRE

Choosing which type of sleeping bag you will buy starts with the choice between the two options for filling: A down filled bag or a fibre filled bag. Each filling has its own advantages:

Down

As opposed to fibre filling, down is a natural material and is by definition a more sustainable choice. Nordisk only uses 100 % traceable European white goose down, giving you the highest possible quality and a guarantee that no animals suffer to provide you with insulation. Please refer to our Ethical Down Code.

In addition to the responsibility factor, down bags are extremely soft and have a unique weight to temperature ratio. With down, you get a ridiculously small pack size and an extremely low weight. The down bag is, however, more vulnerable to moisture and getting wet which requires a stricter discipline when handling the bag.

Down breathes better than any other material. Furthermore, down and small feathers absorb the moisture emitted by the body much better than most other materials, offering you a soft, dry sleeping experience.

Down is NOT the same as feathers, as down grows under the outer layer of the feathers on geese and duck and have filaments that link to other down plumules creating air pockets. It is these air pockets - and not the down itself - which provide the fantastic insulation. The general rule of thumb is that the fewer feathers, the better,

which is measured as a percentage where 90/10 means that the mix includes at least 90% down and 10% feathers and other particles. Nordisk only uses high quality European down, Crystal Down, with a special treatment to make them quicker drying as well as preventing odour and mould on the down.

Nordisk down are RDS certified, to secure animal welfare and additionally measured and labelled by EN standards and complies with the EDFA Down Codex and traceability (European Down & Feather Association), which is the only standard which also includes monitoring of actual down standard. The EDFA Down Codex is monitored and controlled by third party (IDFL - International Down & Feather Laboratories).

Fibre

Fibre filling is a synthetic product made from polyester, and it is very popular because of its high level of insulation, its durability, because it dries fast, and it only requires a minimum of maintenance. Actually, today most sleeping bags are made with fibre filling.

The Nordisk Norguard S-PO Eco filling is made from 100 % recycled polyester.

Fibre filling ensures a sleeping bag with a pleasant and soft feel combined with high elasticity and a very good heat insulation. Fibre filling is additionally highly durable even over long term, and it requires only a minimum of maintenance.

Compared to down, a synthetic sleeping bag requires less care in cleaning and storage - and it also performs better when wet. Furthermore, since synthetic filling is less costly than down, a fibre bag offers good value for less money.



Down filling

CRYSTAL DOWN®

We develop equipment for expeditions exploring the coldest areas of the world and therefore, all our products are filled with Crystal Down® - a selection of the absolute finest and most voluminous European down.

Crystal Down® - a masterpiece of nature

Mother nature ensures that all our sleeping bags and garments are highly insulating and keeps you warm while surprisingly light. The secret is the finest insulation material known to man; down - they keep birds warm and yet light enough to fly. Nothing beats Mother Nature. Down are by nature highly packable as they resist a small amount of pressure but gives in under stronger pressure. The down withstand the impact and return to their initial form when uncompressed.

Gentle but tough

The down that warms the goose's chest and belly are excellent. Thousands and thousands of super-soft, keratin filaments grow radially outwards from a tiny centre. Each of these filaments contains innumerable tiny, branch-like fibres with nearly invisible hooks. When the down are packed together, they attach themselves to each other and build thousands of tiny, warmth-retaining air chambers. This natural solution is lighter, more flexible and better insulating than anything that humankind has ever developed.

The loftier, the fluffier

Down are static masterpieces with a fill power (loft) that resists a small amount of pressure but gives in under stronger pressure. Loft is measured by laboratories under the supervision of the International Down and Feather Laboratory (IDFL) in Salt Lake City, USA. The higher the volume, the higher the loft and the quality. Our special down achieve the highest possible bulking power of up to 900 cubic inches. In recognition of its large, organically grown power and beauty they are called Crystal Down®.

Crystal Down® Dry

Down has a tendency to collapse when wet which has kept down fanatics a bit frustrated under very humid conditions. But not anymore. It is possible to prevent the down from absorbing water. That's why we call Crystal Down® treated with this technology Crystal Down Dry®. In 2014, we started to fill the jackets Mode and North with this innovative kind of down. Today we are using Crystal Down Dry® in a large number of products including the Arctic range of high-end sleeping bags and the range of down filled rain jackets.

Down variants

Crystal down is divided in the following

600 / 90-10 Crystal Down

A good loft for most products. Clean feel and relatively light. Provides good insulation and nice breathability. Not the lightest of mix, but one of the warmest if weight is not so important (but still lighter than fibre fillings).

700 / 90-10 Crystal Down

The value for money mix. Here you almost get the very nice feel and breathability of the more expensive and finer down, but at a lower price and a higher weight. They perform very well and are often our go to down in testing and comparing.

700 / 90-10 Crystal Down Dry

Here we use our good experience from the regular down, but making them hydrophobic. These down goes in a lot of our rain-down garments and hardcore sleeping bags. We recommend these in moist or wet areas where you need the extra protection.

750 / 95-5 Crystal Down

When nerdiness pays off. The loft is just a bit higher, and the mix sorting process is a bit longer, but it pays off in performance. You hereby have a down that ensures you better temperature protection at a lower weight and ensures a bit higher breathability.

800 / 95-5 Crystal Down

When the going gets tough and you need the lightest of products to get to your goals. The down being so fine, it can be combined with the finest of nylons and give very low weights and pack sizes. This down is for when performance matters!

900 / 95-5 Crystal Down

Absolute high end down. The most fluffy down available and the ones creating the best heat to weight ratio. Only used in our most radical addiction products and of course our Worlds Lightest products. Unbeatable performance, unbelievable weight.

FACT!

600 - 900+ Fillpower defines the loft of the down. The higher loft, the less down (weight) you need to make the same temperature insulation.

FACT!

90/10 - 95/5 mix, defines the mix percentage of Down and Feathers. The less feathers, the lower weight.

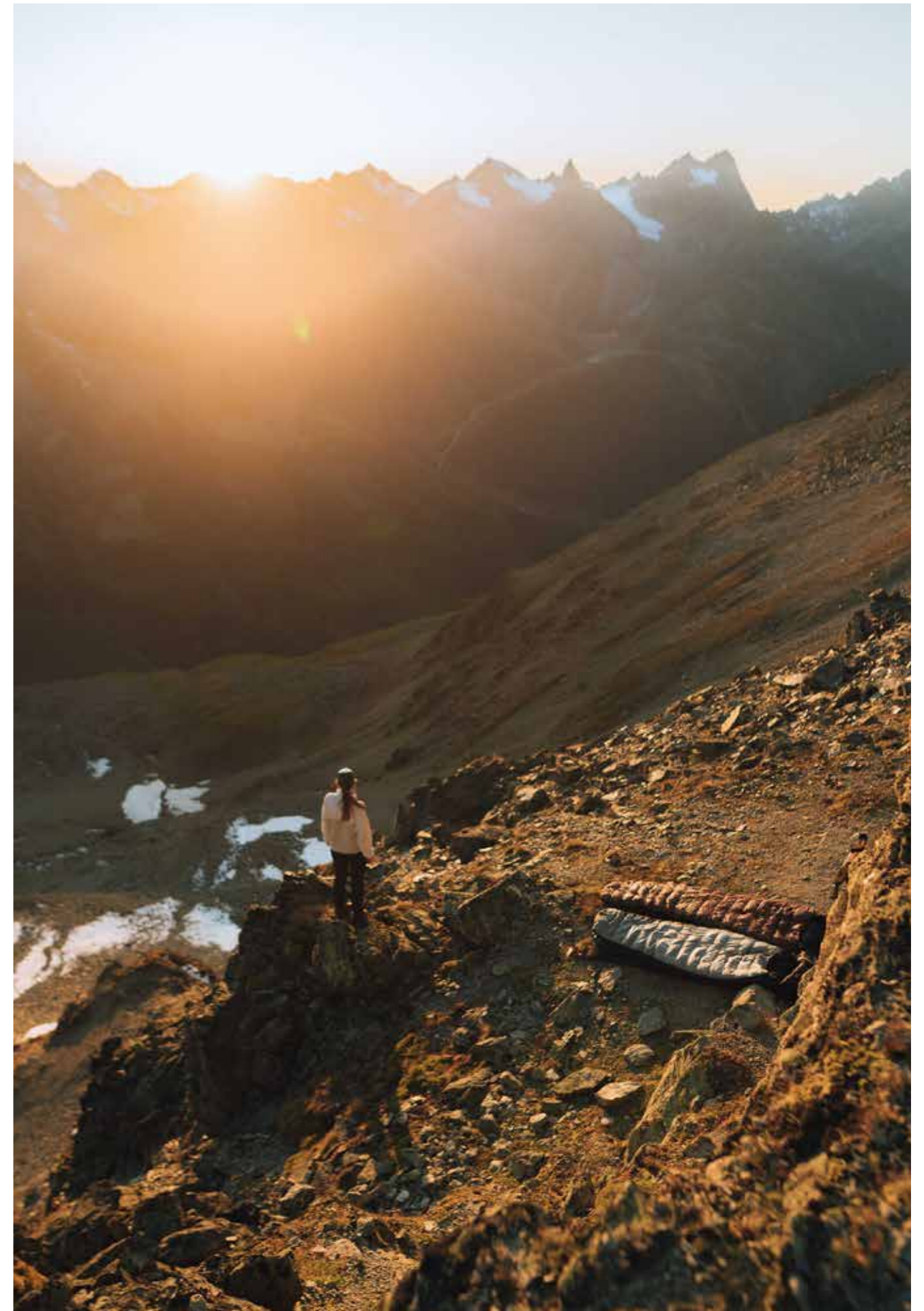



Fibre filling



Norguard S-PO 80

Specially Nordisk developed synthetic fibre filling with soft touch and high loft providing extra warmth for a comfortable sleep. Norguard is non-allergenic and meets Öko-Tex Standard 100.

- Soft touch
- High loft
- High elasticity
- Low maintenance
- Non-allergenic



Norguard S-PO Softcell

Norguard S-PO Softcell, specially developed for Nordisk, is a breakthrough within synthetic fibre filling as you are getting the best of both worlds. With the soft handfeel of down but the performance of synthetic, with its quick-dry properties, Norguard Softcell is practical and comfortable at the same time.

- Handfeel of down
- Quick-dry properties
- Extremely soft



Norguard S-PO Eco

Norguard S-PO Eco is 100% recycled PET. It is a hybrid fibre filling based on a unique mix of micro denier and hollow fibres providing maximum insulation and at the same time a unique dry and very comfortable inner climate - almost no matter the conditions. The hollow fibres optimize the transportation of moisture from bodyheat and the micro denier provide an extreme softness. Together this combination creates a unique micro climate with a distinct and positive effect on perspiration and condensation, thus enhancing comfort.

Furthermore, this special construction makes the filling very flexible and durable, which will prove very useful if you for example wash the sleeping bag often.

- 100% recycled fibre
- Extreme softness
- Ultra high warmth to weight ratio



Norguard S-PO 85

Specially Nordisk developed synthetic fibre filling with extremely soft touch, low maintenance and significantly high loft providing optimal warmth for a the perfect sleep. Norguard S-PO 85 is non-allergenic and meets Öko-Tex Standard 100.

- Extremely soft touch
- Significantly high loft
- Long lifetime
- High elasticity
- Low maintenance
- Non-allergenic



Norguard S-DO 700-90

For Nordisk down products there are placed particular value on a high quality down according to strict standards of animal welfare. Norguard S-DO 700-90 gives perfect insulation yet maintaining a lofty and airy climate for a good night's sleep. In short, for you Norguard down means:

- 600+ cuin minimum fill power
- Lighter weight compared to synthetic fibre
- Focus on animal welfare
- European down



Norguard S-PO S-Core

Norguard S-PO S-Core is a highly technical synthetic fibre filling which has taken the leading position in the market when it comes to extreme softness combined with insulation value.

A breathable membrane combined with a layered fibre construction creates a multi-faceted and versatile performance as each layer offers its own unique benefit. The membrane is effectively transformed into a virtual pump, actively drawing moisture away while retaining warmth within.

- Extreme thermal efficiency
- Breathable membrane
- Versatile performance capabilities
- All time dryness
- Draws away moisture while retaining warmth within

Sleeping bag features



Contour Hood/3D Hood
With draw cord for optimal heat retention.

Secondary Shoulder Zipper
To stick the arm out while leaving the chest area covered/insulated.
*applies to selected AMBITION and ADDICTION sleeping bags.

Technical Label
Located along zipper opening. Clear information about EN tested temperature rating and composition.

Chamber Gap Zipper
Concealed, can be opened to lower the insulation value in warmer nights.
*applies to selected ADDICTION sleeping bags.

Soft Touch Lining
For pleasant hand feel and cosy, comfortable nights. Breathable and fast drying.

Footbox Opening
To allow for ventilation in warmer nights.
*applies to selected AMBITION and ADDICTION sleeping bags.

Thermal Collar
To prevent cold from entering the bag.
*applies to Nordisk 3-Season, Winter and Extreme bags.

Zipper Garage
No cold metal against your face. Temperature indication on zipper garage.

Nordisk Zipper Puller
For easy grip.

Zipper Protection
Parallel stitching to prevent zipper from snagging and avoid scratching edges, which traditional zipper protection bands often causes.

Zipper Draft Tube
Preventing cold spots.

Inner Pocket
Easy reachable inner pocket for storing valuables smartphone readable through mesh.

Reversed 2-Way Zipper
Appropriate zipper length chosen according to each style, season and usage.

*reference picture shows Gormsson -2° Curve

Season description



SUMMER ABOVE +4

If mainly using a sleeping bag in warmer temperature, then the Nordisk high summer bag is the right choice. At Nordisk, we like to keep it simple, and therefore all Nordisk summer bags are constructed to reach a +10°C temperature rating, however, anything above +4°C is categorised as a Summer bag. A summer bag is used for warm climate. It is often humid and plenty of ventilation is therefore required. A Nordisk summer bag comes with full length zipper to maximize ventilation. The hood construction is contoured to cater as a comfortable blanket for your head during the warmer nights. If needed the hood can be tightened around your head to provide more heat. In warmer climate a sleeping bag is often used fully open, and there is no need for it to be tightened closely around your body. For this exact reason summer bags are not constructed with a neck baffle.



3-SEASON +3 TO -2°

The majority of sleeping bags sold are 3-Season bags as this is the most versatile bag which can be used in a lot of conditions as long as it is not too cold. All Nordisk 3-Season bags are constructed to reach -2°C rating but temperature rating from +3°C to -2°C is considered a 3-Season bag. A 3-Season bag is ideal for the Nordic climate. It is not too big and bulky nor too warm for the average Nordic summer nights. As it can get cold at night during summer, a summer bag might be too cold. A 3-Season bag still provides plenty of ventilation options. It is constructed with full length zipper but different to the summer bag it has a 3D hood as well as a neck baffle to cater for colder nights where you want to keep all heat in the bag.



WINTER -3 TO -15°

Nordisk winter bags are only available in the mummy shape as all cold spots are kept to a minimum, performance is key and mummy bags offer the optimal heat retention. Nordisk winter bags reach -10°C, however anything from -3°C to -15°C is considered a Winter bag. A winter bag is used for expeditions and is for the more experienced segment of the outdoor market or for guided tours where winter sleeping bags are required. All winter bags are constructed with knee-length zipper to prevent heat loss but still allow for comfort and ventilation. The hood is fitted, and neck baffle applies to cater for optimal insulation.

EXTREME BELOW -16°

For extreme expeditions with very cold climate Nordisk Extreme bags are the go to. They rate at -20°C but anything from -16°C to -25°C falls into the Extreme category. An extreme bag is used for expeditions only and is purely performance driven. Comfort inside the bag is important as you often live in the bag for many hours a day when you are not moving. This also means the bag need to cater for this providing a bit more room for reading, eating and perhaps wearing clothes and boots inside the bag. All Nordisk Extreme bags have got waist length zipper to prevent heat loss but still allow for comfort and ventilation. The hood is fitted and can be closed tightly around the head to keep in the heat. Furthermore, the extreme bags are designed with a hood baffle and a neck baffle.



Construction Details

The construction of the sleeping bag defines how the filling is kept in place and layered inside the bag. This defines how well the filling insulates and ultimately decides in how cold environments the sleeping bag can be used.

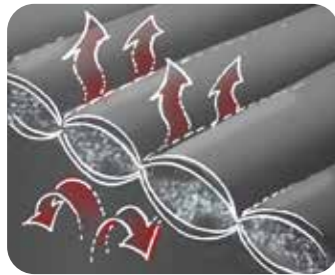

Stitched Through
The most simple design for a sleeping bag is to use the stitched through construction. Using this method the shell and lining are stitched together directly on top of each other to create the chambers into which the filling is inserted.

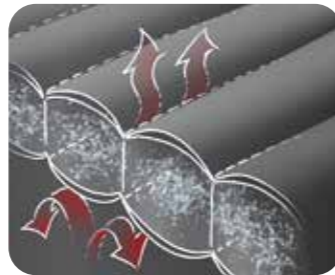

H-Box
The H-box, H-chamber or Box Wall Construction is divided into different chambers with vertical side walls to keep the insulation in place and to avoid cold bridges. This ensures a uniform thickness of insulation all through the sleeping bag.

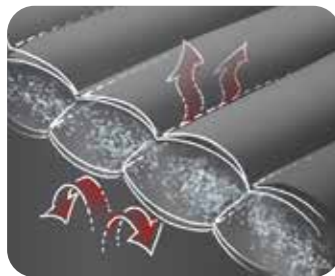

S-Box
A slanted wall construction creates a more difficult path for heat to escape along the relatively low-density insulation area against the side wall. This improves the thermal efficiency of the bag even more than H-box construction.

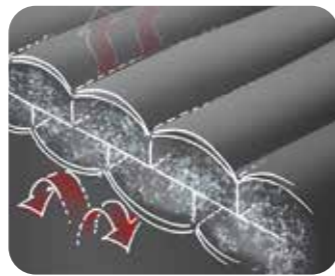

Offset double box wall
The two box wall layers, one on top of each other, have their baffle walls offset relative to each other, which creates an appearance similar to that of a brick wall. Often used in bags with a large amount of filling - typically for extreme conditions.

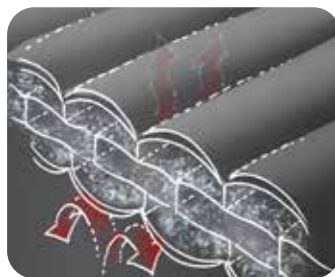

Offset triple box
Offset triple box is basically designed as the Offset Double Box wall construction, but with an extra layer. The third layer adds to the unique insulation by increasing the volume and the temperature level. Best suited for sleeping in extreme cold.

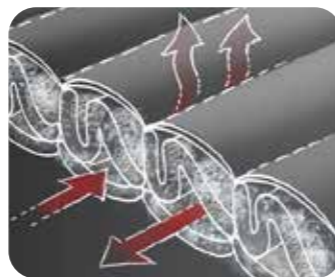

Tubic
With tubic construction technology a pair of arched insulation fibres runs in a vaulted formation through the entire length of the vertical thermal channels. The added loft traps more air, increases heat distribution and reduces heat escape options. The result is a 3-dimensional loft optimization and higher thermal efficiency.

Sleeping Bag / Shape



Blanket
The Nordisk rectangular Blanket shape is highly rated due to its versatile use. It can be used as a regular sleeping bag, or a blanket, if you find it uncomfortable being enclosed inside the bag.



Egg
Nordisk Egg shape offers a good balance between insulation and space. Freedom of movement is at its most. This is often of interest to the user who does not use the sleeping bag frequently, and who is not exposed to extreme temperatures.



Mummy
Nordisk Mummy shape is fitted the human body contour, offering a snug fit with optimal insulation properties as air gaps are kept to a minimum. The Mummy shape is ideal for any outdoor enthusiast to whom performance is key.

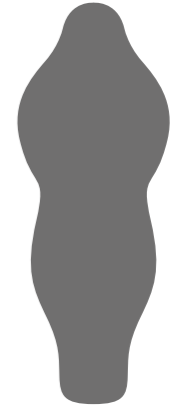

Curve
The Curve shape by Nordisk is the optimal balance between insulation and space. The majority of people sleep in a "running" position where the body makes an S-shape. The Curve shape allows more comfort and space for this position.

Sleeping Bag / Zipper

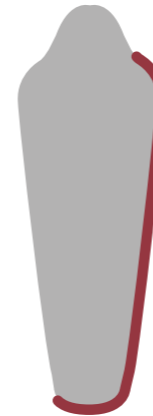

Complete Zip
This zipper allows to completely open the sleeping bag, front and back laying flat.

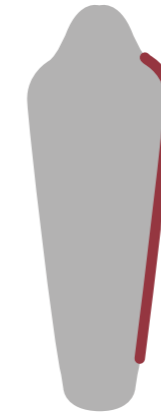

Side Zip
This zipper allows to open the sleeping bag, but keep the feet warm in the closed footbox.

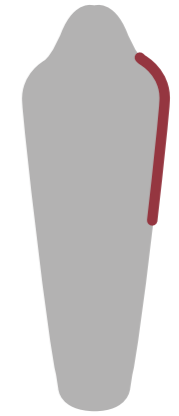

Half Side Zip
This zipper saves on weight and pack size and is best used on lightweight/race sleeping bags.

Sleeping Bag / Size

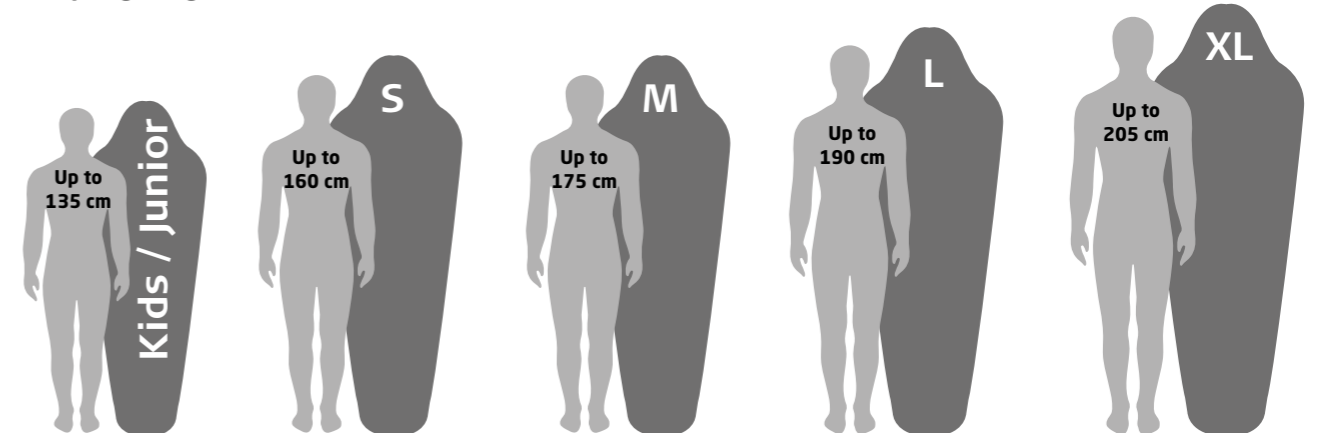

Nordisk sleeping bags are measured from the top of the hood to the footend. Measure your full Body Length to find the ideal sleeping bag size. All sleeping bags measure 20 cm more than the recommended Body Length.

Tent Fabric

NORDISK COTTON

Flysheet, Technical Cotton

Composition: 65% Polyester / 35% Cotton
 Construction: Technical weave
 with breathable finish
 Weight: 210 g/m²
 Water column: 350 mm

Inner Tent

Composition: 65% Polyester / 35% Cotton
 Floor: 150D Oxford Polyester
 Weight: 105 g/m²
 Features: Breathable and
 water repellent

Mesh

Composition: 100% Nylon
 Construction: Mosquito Mesh

Groundsheet

Composition: 150D Tarpaulin
 REACH compliant
 Construction: Coated mesh
 Weight: 540 g/m²
 Water column: 100% waterproof

Turtle Hub®

The Turtle Hub® is a flexible padded pole hub system consisting of individual pole pockets sharing the same reinforced "shell", creating a perfect hold and an even tension distribution from the poles. The Turtle Hub® provides extraordinary stability and prevents individual poles from moving against or away from each other, thus it becomes possible to create pole structures like A-frames or T-junctions without using bulky connections or additional connector elements. Even though a tent construction would be based entirely on single poles that are not connected to one another, the Turtle Hub® will provide massive strength and stability, hold the poles tight and distribute pushing force evenly.

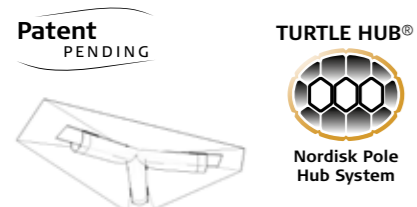

Example position for Turtle Hub - all individual poles meet protected under the shell



FACT!

What is Technical Cotton?
 Technical Cotton is characterised by high breathability and higher durability, due to the mix of the natural features of cotton combined with the strength of man-made polyester yarn.

Tent Fabric

NORDISK PU

Flysheet

Composition: 100% Polyester
 Construction: Rip-stop
 Treatment: UV 45+ filter and PU
 Yarn thickness: 68D
 Thread count: 185T
 Weight: 82 g/m²
 Water column: 3000 mm

Inner Tent

Composition: 100% Polyester
 Construction: Plain weave
 Yarn thickness: 68D
 Thread count: 185T
 Weight: 51 g/m²
 Features: Breathable and
 water-repellent

Mesh

Composition: 100% Polyester
 Construction: No-See-Um Mesh
 Weight: 54 g/m²

Groundsheet

Composition: 100% Oxford Polyester
 Yarn thickness: 150D
 Weight: 109 g/m²
 Water column: 8000 mm

NORDISK SI

Flysheet

Composition: 100% Nylon
 Construction: Rip-stop
 Treatment: Silicon coating, double
 sided, 3 layers each side
 Yarn thickness: 40D
 Thread count: 240T
 Weight: 58 g/m²
 Water column: 3000 mm
 Tearing strength: 15.1 kg

Inner Tent

Composition: 100% Nylon
 Construction: Rip-stop
 Yarn thickness: 40D
 Thread count: 240T
 Weight: 50 g/m²
 Features: Breathable
 Water repellent

Mesh

Composition: 100% Polyester
 Construction: No-See-Um Mesh
 Weight: 40 g/m²

Groundsheet

Composition: 100% Nylon
 Treatment: PU coated
 Yarn thickness: 150D
 Thread count: 210T
 Weight: 90 g/m²
 Water column: 8.000 mm

NORDISK LW/ULW

Flysheet

Composition: 100% Nylon
 Construction: Rip-stop
 Treatment: Silicon coating,
 double sided,
 3 layers each side
 Yarn thickness: 10D / Lofoten 7D
 Thread count: 455T
 Weight: 30 g/m² / Lofoten 20/m²
 Water column: 2000 mm
 Tearing strength: 8 kg

Inner Tent

Composition: 100% Nylon
 Construction: Rip-stop
 Yarn thickness: 15D
 Thread count: 341T
 Weight: 26 g/m²
 Features: Breathable
 Water repellent

Mesh

Composition: 100% polyester
 Construction: No-See-Um Mesh

Groundsheet

Composition: 100% Nylon
 Construction: Rip-stop
 Treatment: PU coated
 Yarn thickness: 20D / Lofoten 15D
 Weight: 53 g/m²
 Water column: 8000 mm



FACT!

What is PU?
 Ideal for the occasional or first time outdoor hiking experience, where you wish to stay overnight and still be well protected.
 PU is short for Polyurethane. This fabric treatment gives you rain protection and strong stability. Oh yes, and then there are the taped seams. Perfect in any weather conditions.

FACT!

What is SI?
 The trekkers choice. Lightweight and strong without compromise in rugged conditions.
 SI is short for Silicone. This fabric treatment ensures your tent a better flexibility and offers a lighter yet stronger result. SI gives you rain protection and thereby a high degree of a dry experience despite rain.

New weight definition:
Total weight (excl. hangtag)
Net weight (excl. packsacks, bonus pack, repair, footprint, and canopy poles)
Trim weight (minimal functional weight)

1-2 persons

3-4 persons

5-6 persons

8+ persons

SPIRIT



Asgard Tech Mini Ydun Tech Mini



Ydun Sky 5.5 m² Vimur 4.8 m²



Asgard 7.1 m² (2.0) Vimur 5.6 m²



Thrymheim 3 Reisa 4 PU



Midgard 9.2 m² Alfheim 12.6 m²



Asgard 12.6 m² (3.0) Utgard Sky 13.2 m²



Thrymheim 5 Reisa 6 PU



Midgard 20 m² Vanaheim 24 m²



Alfheim 19.6 m²



Asgard 19.6 m² (3.0)



Vanaheim 40 m²

AMBI TION



Telemark 2.2 PU Svalbard 1 PU/SI Oppland 2 PU/SI Halland 2 PU



Oppland 3 PU/SI Oppland 4 PU

AD DIC TION



Lofoten 1 ULW Lofoten 2 ULW Halland 2 LW Telemark 1 LW Oppland 2 LW Telemark 2 LW



Oppland 3 LW



Tent overview - Spirit



SPIRIT	Midgard 9.2 m ²	Midgard 20 m ²	Vimur 4.8 m ²	Vimur 5.6 m ²
Item no. / colour	142029 / Sandshell	142033 / Sandshell	142030 / Sandshell	142031 / Sandshell
Persons	6	10	4	4
Measurements flysheet	303 x 303 x 270 cm	450 x 450 x 300 cm	240 x 207 x 134 cm	240 x 240 x 206 cm
Measurements inner tent	NA	NA	NA	NA
Material flysheet	Technical Cotton 65% Polyester, 35% Cotton	Technical Cotton 65% Polyester, 35% Cotton	Technical Cotton 65% Polyester, 35% Cotton	Technical Cotton 65% Polyester, 35% Cotton
Material inner tent	NA	NA	NA	NA
Material groundsheet	100% waterproof Tarpaulin	100% waterproof Tarpaulin	100% waterproof Tarpaulin	100% waterproof Tarpaulin
Water column fly	350 mm	350 mm	350 mm	350 mm
Water column ground	100% waterproof	100% waterproof	100% waterproof	100% waterproof
Net weight	27.800 g	42.500 g	14.200 g	18.700 g
Total weight	29.000 g	44.500 g	15.000 g	19.700 g
Pack size	Flysheet: 40 x 110 cm Poles: 20 x 70 cm	Flysheet: 46 x 110 cm Poles: 35 x 70 cm	Flysheet: 31 x 80 cm Poles: 20 x 61 cm	Flysheet 36 x 84 cm Poles 11 x 58 cm
Guy line	5.0 mm Polyester string with Aluminium Triangular Slider	5.0 mm Polyester string with Aluminium Triangular Slider	5.0 mm Polyester string with Aluminium Triangular Slider	5.0 mm Polyester string with Aluminium Triangular Slider
Poles	Steel	Steel	Steel	Steel
Pegs	Steel	Steel	Steel	Steel
Available extras	-	-	-	-



SPIRIT	Midgard Connector	Midgard Annex Small	Midgard Annex Large	Vimur Zip Adapter Small	Vimur Zip Adapter Large
Item no. / colour	107269 / Sandshell	107270 / Sandshell	107271 / Sandshell	107272 / Sandshell	107273 / Sandshell
Persons	-	approx. 1 adult + kids	approx. 1 adult + kids	-	-
Measurements flysheet	126 x 240 x 206 cm	207/100 x 145 x 134 cm	240/100 x 200 x 206 cm	50 x 207 x 134 cm	50 x 240 x 206 cm
Measurements inner tent	-	-	-	-	-
Material flysheet	Technical Cotton 65% Polyester, 35% Cotton	Technical Cotton 65% Polyester, 35% Cotton	Technical Cotton 65% Polyester, 35% Cotton	Technical Cotton 65% Polyester, 35% Cotton	Technical Cotton 65% Polyester, 35% Cotton
Material inner tent	-	-	-	-	-
Material groundsheet	100% waterproof Tarpaulin	100% waterproof Tarpaulin	100% waterproof Tarpaulin	-	-
Water column fly	350 mm	350 mm	350 mm	350 mm	350 mm
Water column ground	100% waterproof	100% waterproof	100% waterproof	-	-
Net weight	5.000 g	4.100 g	6.300 g	800 g	1000 g
Total weight	5.500 g	4.600 g	6.700 g	-	-
Pack size	18 x 42 cm	17 x 41 cm	20 x 44 cm	14 x 27 cm	18 x 27 cm
Guy line	5.0 mm Polyester string with Aluminium Triangular Slider	5.0 mm Polyester string with Aluminium Triangular Slider	5.0 mm Polyester string with Aluminium Triangular Slider	5.0 mm Polyester string with Aluminium Triangular Slider	5.0 mm Polyester string with Aluminium Triangular Slider
Poles	-	-	-	-	-
Pegs	Steel	Steel	Steel	Steel	Steel
Available extras	-	-	-	-	-

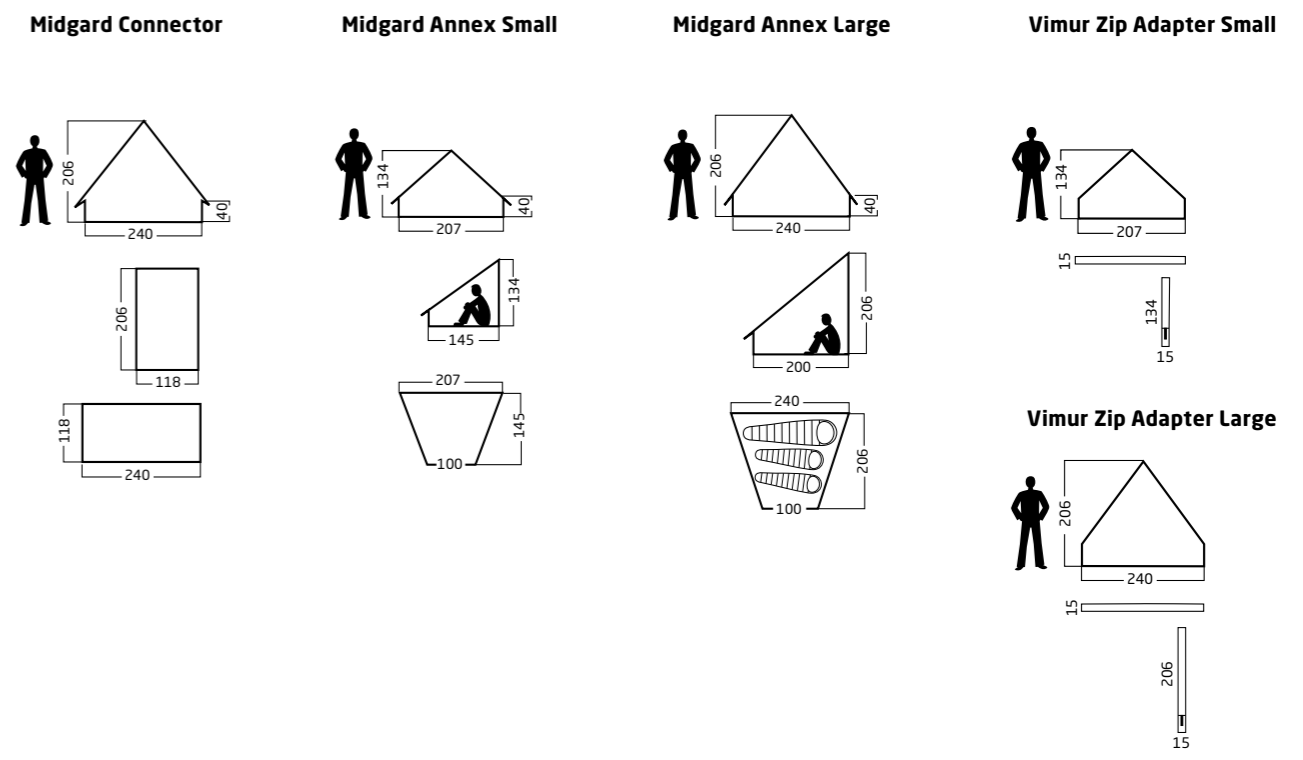
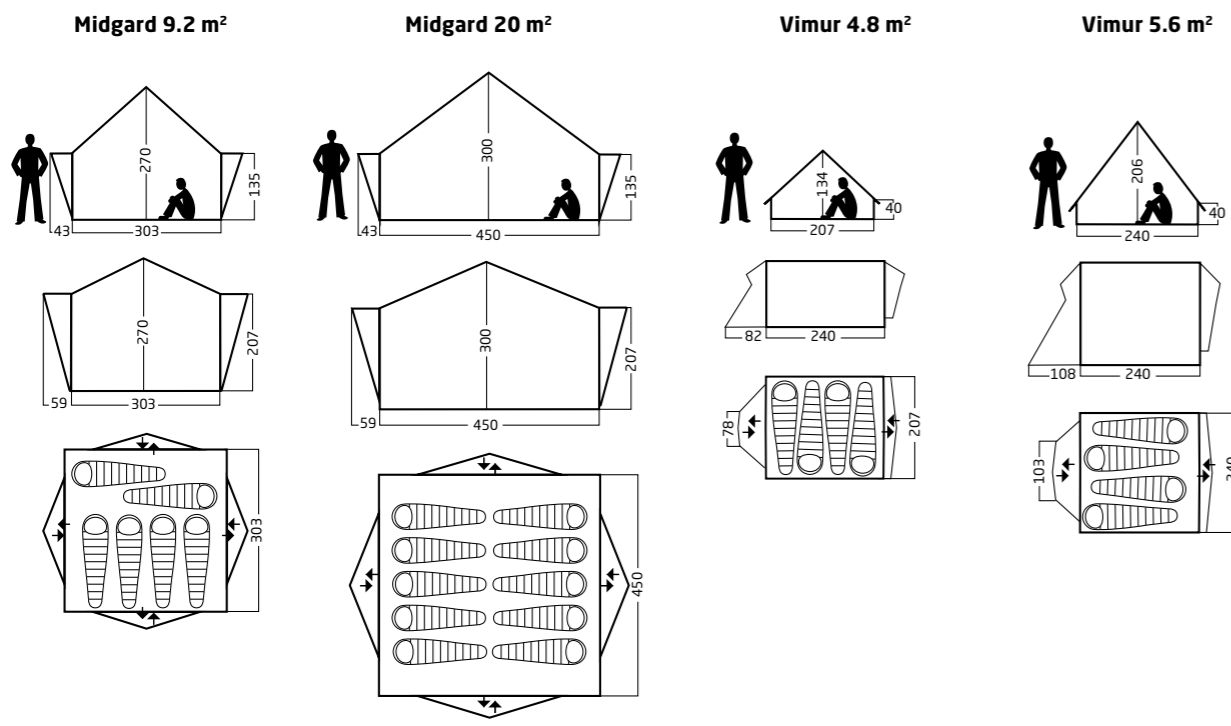

Tent overview - Spirit



SPIRIT	Asgard 7.1 m ² (2.0)	Asgard 12.6 m ² (3.0)	Asgard 19.6 m ² (3.0)	Asgard 7.1 m ² Denim (2.0)
Item no. / colour	142063 / Sandshell	142064 / Sandshell	142069 / Sandshell	10921008 / Denim
Persons	3 (2 with cabin)	6 (2-3 with cabin)	8-10 (4 with cabins)	3 (2 with cabin)
Measurements flysheet	300 x 265 x 200 cm	400 x 375 x 250 cm	500 x 470 x 300 cm	300 x 265 x 200 cm
Measurements inner tent	Inner cabin available as add-on			Inner cabin available as add-on
Material flysheet	Technical Cotton, 65% Polyester, 35% Cotton			Technical Cotton, 65% Polyester, 35% Cotton
Material inner tent	Inner cabin available as add-on			
Material groundsheet	150D Tarpaulin	Zip-in floor available as add-on		150D Tarpaulin
Water column fly	350 mm			350 mm
Water column ground	100% waterproof	-	-	100% waterproof
Net weight	16.400 g	17.500 g	19.700 g	-
Total weight	17.200 g	18.400 g	20.600 g	14.500 g
Pack size	29 x 85 cm	27 x 93 cm	42 x 116 cm	30 x 97 cm
Windtest	-	-	-	-
Guy line	High Tenacity Polyester 5.0 mm with Aluminium Triangular Slider			High Tenacity Polyester 5.0 mm with Aluminium Triangular Slider
Poles	Adjustable Steel poles	Adjustable Steel poles	Adjustable Steel poles	Aluminium
Canopy poles	-	-	-	-
Pegs	Steel V-Peg	Steel V-Peg	Steel V-Peg	Nordisk Stainless Steel nails
Available extras	Inner cabin	Inner cabin, Zip-in floor	Inner cabin, Zip-in floor	Inner cabin



SPIRIT	Alfheim 12.6 m ²	Alfheim 19.6 m ²	Ydun Tech Mini	Asgard Tech Mini
Item no. / colour	142013 / Sandshell	142014 / Sandshell	148051 / Sandshell	148055 / Sandshell
Persons	6 (2-3 with cabin)	8-10 (4 with cabin)	2	2
Measurements flysheet	400 x 400 x 275 cm	500 x 500 x 350 cm	210 x 155 x 125 cm	246 x 210 x 160 cm
Measurements inner tent	Inner cabin available as add-on		-	-
Material flysheet	Technical Cotton, 65% Polyester, 35% Cotton		Flysheet: Technical Hybrid Roof: Technical Nylon (100% Nylon, PU-coated, taped) Walls-Doors: Technical Cotton (65% Polyester, 35% Cotton)	
Material inner tent	Inner cabin available as add-on		-	-
Material groundsheet	Zip-in floor available as add-on		100% Polyester, PU-coated, taped	
Water column fly	350 mm		600 mm	
Water column ground	-	-	1000 mm	
Net weight	12.700 g	19.700 g	4.300 g	4.300 g
Total weight	13.400 g	20.500 g	4.500 g	4.600 g
Pack size	32 x 99 cm	36 x 99 cm	28 x 20 x 26 cm	28 x 20 x 26 cm
Windtest	-	-	-	-
Guy line	High Tenacity Polyester 5.0 mm with Aluminium Triangular Slider		Ydun Mini Colour pack - essential add-on Sold separately	Asgard Mini Colour pack - essential add-on Sold separately
Poles	Steel	Steel	Item no. 148052 / Mustard Item no. 148053 / Cherry Item no. 148054 / Chocolate	Item no. 148056 / Mustard Item no. 148057 / Cherry Item no. 148058 / Chocolate
Canopy poles	-	-		
Pegs	Steel V-Peg	Steel V-Peg		
Available extras	Inner cabin, Zip-in floor	Inner cabin, Zip-in floor	Footprint	Footprint

Asgard 7.1 m²

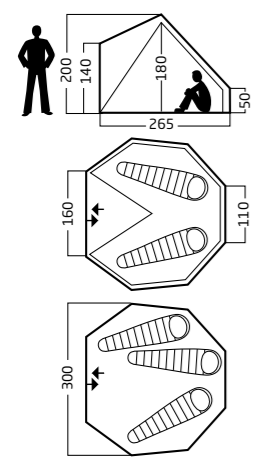

Asgard 12.6 m²

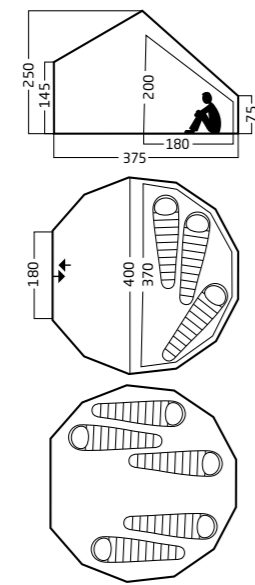

Asgard 19.6 m²

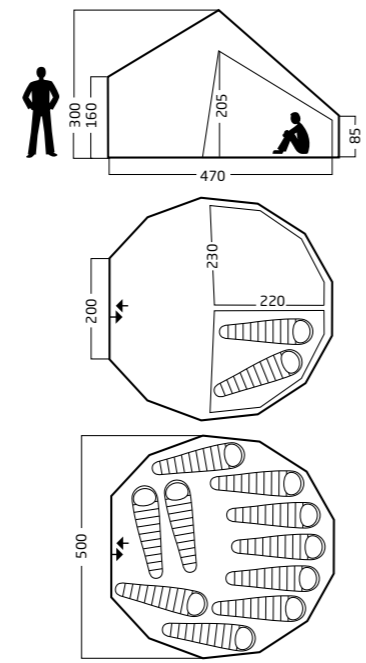

Alfheim 12.6 m²

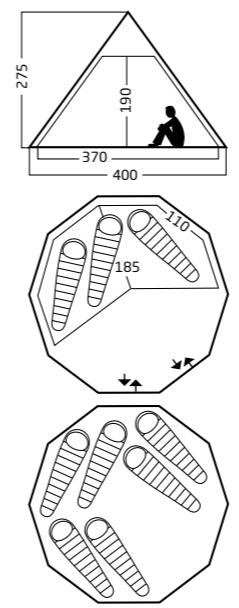

Alfheim 19.6 m²

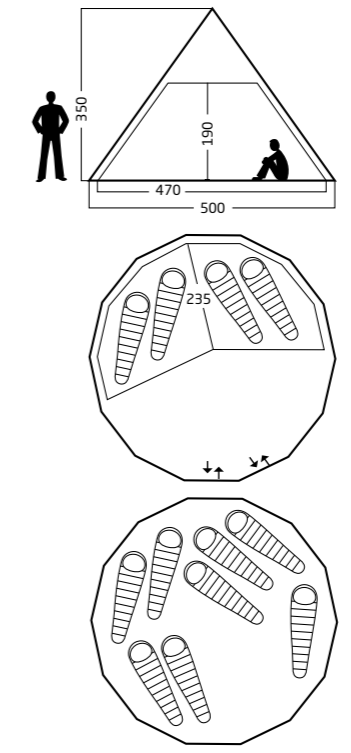

Ydun Tech Mini

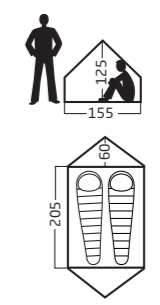

Asgard Tech Mini

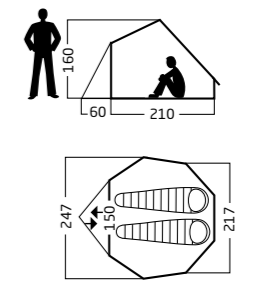

Tent overview - Spirit



SPIRIT	Ydun Sky 5.5 m ²	Utgard Sky 13.2 m ²	Vanaheim 24 m ²	Vanaheim 40 m ²
Item no. / colour	142059 / Sandshell	142061 / Sandshell	142016 / Sandshell	142020 / Sandshell
Persons	4 (3 with cabin)	6 (4 with cabins)	16 (6 with cabins)	20 (8 with cabins)
Measurements flysheet	210 x 260 x 150 cm	430 x 295 x 240 cm	600 x 400 x 300 cm	800 x 495 x 300 cm
Measurements inner tent	195 x 205 x 130 cm	Inner cabin available as add-on	Inner Cabin available as add-on	Inner Cabin available as add-on
Material flysheet	Technical Cotton 65% Polyester, 35% Cotton	Technical Cotton 65% Polyester, 35% Cotton	Technical Cotton 65% Polyester, 35% Cotton	Technical Cotton 65% Polyester, 35% Cotton
Material inner tent	Inner cabin available as add-on	Inner cabin available as add-on	Inner cabin available as add-on	Inner cabin available as add-on
Material groundsheet	150D Tarpaulin / Sewn-in floor	Zip-in floor available as add-on	Zip-in floor available as add-on	Zip-in floor available as add-on
Water column fly	350 mm	350 mm	350 mm	350 mm
Water column ground	100% waterproof	-	-	-
Net weight	14.800 g	23.100 g	43.400 g	55.200 g
Total weight	15.300 g	24.000 g	45.400 g	57.400 g
Pack size	30 x 66 cm	31 x 103 cm	63 x 124 cm	72 x 124
Guy line	High Tenacity Polyester 5.0 mm with Aluminium Triangular Slider	High Tenacity Polyester 5.0 mm with Aluminium Triangular Slider	High Tenacity Polyester 5.0 mm with Aluminium Triangular Slider	High Tenacity Polyester 5.0 mm with Aluminium Triangular Slider
Poles	Adjustable Steel poles	Adjustable Steel poles	Steel	Steel
Pegs	Steel V-Peg Steel Skewer	Steel	Steel V-Peg	Steel V-Peg
Available extras	Inner cabin	Inner cabin, Zip-in floor	Inner cabin, Zip-in floor	Inner cabin, Zip-in floor



SPIRIT	Reisa 4	Reisa 6	Thrymheim 3	Thrymheim 5
Item no. / colour	122056 / Cashew	122057 / Cashew	122055 / Picante-Cashew	122054 / Picante-Cashew
Persons	4 (converts to 3)	6 (converts to 4)	3	5
Measurements flysheet	495 x 230 x 190 cm	645 x 295 x 210 cm	320 x 235 x 210 cm	495 x 295 x 265 cm
Measurements inner tent	230 x 200 x 180 cm 110 x 200 x 160 cm	230 x 280 x 200 cm 160 x 280 x 170 cm	153-226 x 221 x 202 cm	180-275 x 280 x 257 cm
Material flysheet	100% Polyester, Rip-stop, PU		100% Polyester, Rip-stop, PU	
Material inner tent	100% Polyester, breathable, water-repellent with No-See-Um Mesh		100% Polyester, breathable, water-repellent with No-See-Um Mesh	
Material groundsheet	100% Oxford Polyester		100% polyester	
Water column fly	3000 mm		3000 mm	
Water column ground	8000 mm		8000 mm	
Net weight	11.600 g	18.900 g	7.400 g	9.900 g
Total weight	11.800 g	19.200 g	7.700 g	10.200 g
Pack size	25 x 65 cm	35 x 70 cm	22 x 55 cm	25 x 57 cm
Windtest	15,0 m/sec	17,5 m/sec	NA	NA
Guy line	3 mm Polyester with Aluminium Peanut Sliders		2.5 mm Polyester with Aluminium Triangular Slider	
Poles	Aluminium	Aluminium	Aluminium	
Canopy poles	Aluminium	Aluminium	-	-
Pegs	Aluminium Square Skewer	Aluminium Square Skewer	Aluminium Y-Pegs	Aluminium Y-Pegs
Available extras	Spare poles, Footprint	Spare poles, Footprint	Canopy poles	Canopy poles

Ydun Sky 5.5 m²

Utgard Sky 13.2 m²

Vanaheim 24 m²

Vanaheim 40 m²

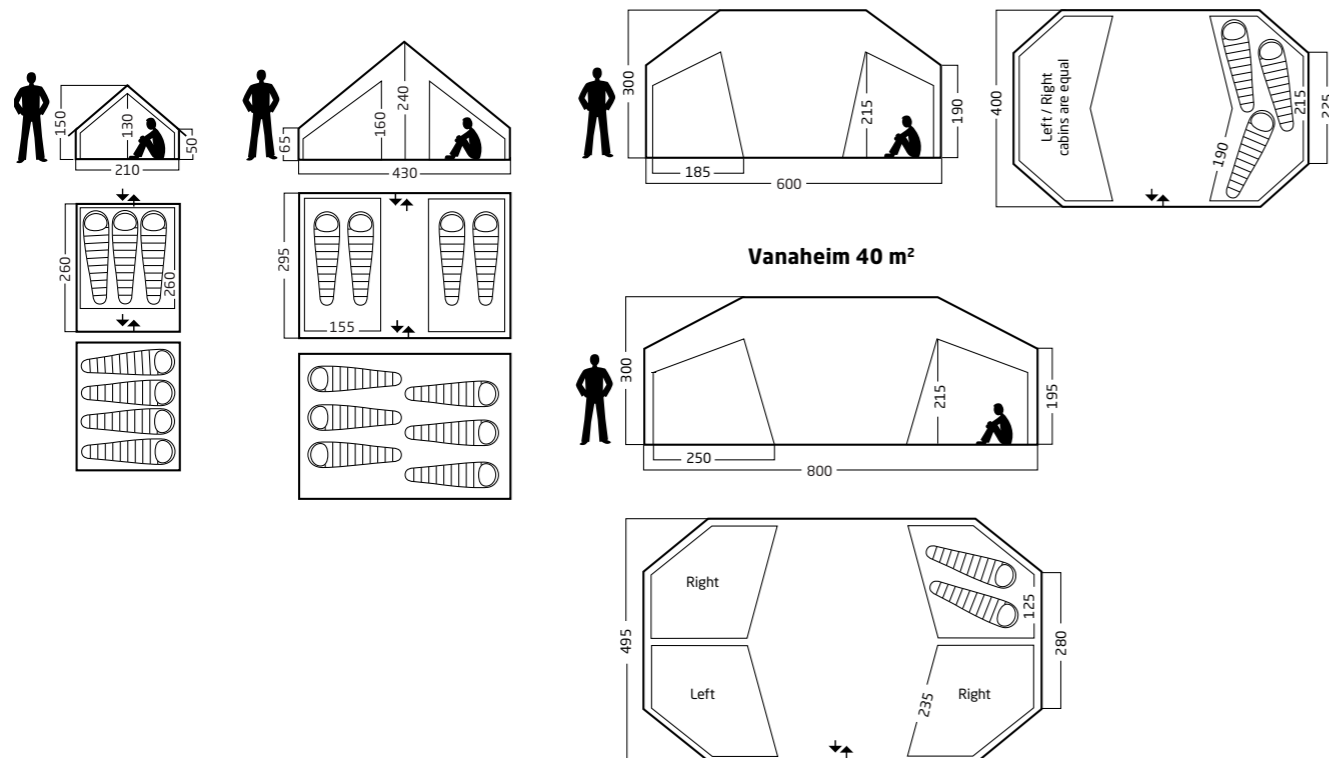

Reisa 4 PU

Thrymheim 3 PU

Thrymheim 5 PU

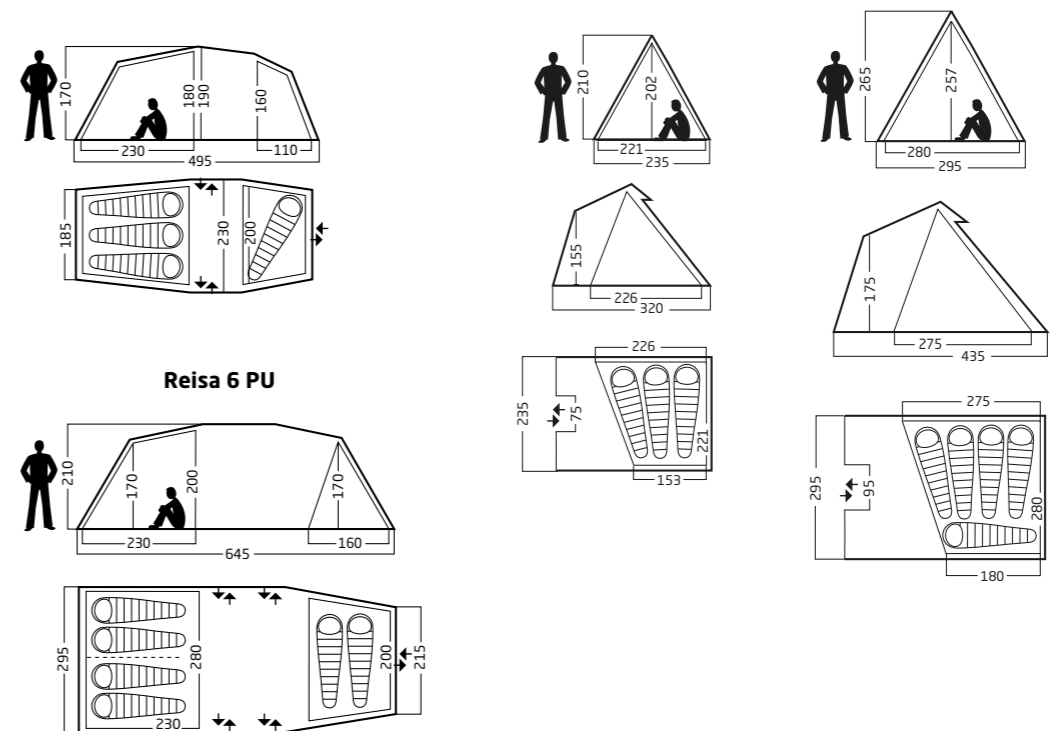

Tent overview - Ambition



AMBITION	Svalbard 1 PU	Svalbard 1 SI	Otra 2 PU	Telemark 2.2 PU	Halland 2 PU
Item no. / colour	122059 / Dark Olive	112027 / Forest Green	122063 / Dark Olive	122058 / Dark Olive	122062 / Dark Olive
Persons	1	1	2	2	2
Measurements flysheet	275 x 125 x 105 cm	275 x 125 x 105 cm	240 x 300 x 120 cm	240 x 180 x 106 cm	350 x 150 x 110 cm
Measurements inner tent	265 x 115 x 100 cm	265 x 115 x 100 cm	225 x 150 x 115 cm	216 x 130 x 91 cm	215 x 130 x 100 cm
Material flysheet	100% Polyester, Rip-stop, PU	100% Nylon, Rip-stop, 40D	100% Polyester, Rip-stop, PU	100% Polyester, Rip-stop, PU	100% Polyester, Rip-stop, PU
Material inner tent	100% Polyester, breathable, water-repellent with No-See-Um Mesh	100% Nylon, breathable, water-repellent	100% Polyester, breathable, water-repellent with No-See-Um Mesh	100% Polyester	100% Polyester, breathable, water-repellent with No-See-Um Mesh
Material groundsheet	100% Oxford Polyester	100% Nylon, 40D	100% Oxford Polyester	100% Oxford Polyester	100% Oxford Polyester
Water column fly	3000 mm	3000 mm	3000 mm	3000 mm	3000 mm
Water column ground	8000 mm	10000 mm	8000 mm	8000 mm	8000 mm
Net weight	2.200 g	1.900 g	4.350 g	2.150 g	3.150 g
Total weight	2.350 g	2.150 g	4.600 g	1.900 g	3.350 g
Pack size	12 x 50 cm	15 x 45 cm	18 x 53 cm	15 x 44 cm	15 x 50 cm
Windtest m/sec.	40,0 m/sec	40,0 m/sec	20,0 m/sec		25,0 m/sec
Guy line	2,5 mm Polyester with Aluminium Peanut Sliders	2,5 mm Nylon with Aluminium Triangular Sliders	2,5 mm Polyester with Aluminium Peanut Sliders	2 mm Dyneema	2,5 mm, Polyester with Aluminium Peanut Sliders
Poles	Aluminium	Aluminium DAC Featherlike NSL, Green Anodized	Aluminium	Aluminium	Aluminium
Pegs	Aluminium Square Skewer	Aluminium Y-Pegs	Aluminium Square Skewer	Aluminium Y-Pegs	Aluminium Square Skewer
Available extras	Spare poles, Footprint	Spare poles, Footprint	Spare poles	Spare poles, Footprint	Spare poles, Footprint



AMBITION	Oppland 2 PU	Oppland 3 PU	Oppland 4 PU	Oppland 2 SI	Oppland 3 SI
Item no. / colour	122076 / Dark Olive	122077 / Dark Olive	122078 / Dark Olive	112032 / Forest Green	112033 / Forest Green
Persons	2	3	4	2	3
Measurements flysheet	435 x 160 x 110 cm	435 x 210 x 117 cm	470 x 255 x 129	430 x 165 x 110 cm	430 x 210 x 120 cm
Measurements inner tent	220 x 145 x 100 cm	220 x 190 x 107 cm	230 x 227 x 120	220 x 145 x 100 cm	225 x 190 x 110 cm
Material flysheet	100% Polyester, Rip-stop, PU			100% Nylon, Rip-stop, 40D	
Material inner tent	100% Polyester, breathable, water-repellent with No-See-Um Mesh			100% Nylon, breathable, water-repellent	
Material groundsheet	100% Oxford Polyester			100% Nylon, 40D	
Water column fly	3000 mm			3000 mm	
Water column ground	8000 mm			10000 mm	
Net weight	3.600 g	4.200 g	4.650 g	2.900 g	3.550 g
Total weight	3.800 g	4.300 g	4.900 g	3.050 g	3.750 g
Pack size	20 x 50 cm	20 x 55 cm	20 x 55 cm	15 x 50 cm	20 x 50 cm
Windtest m/sec.	22,5 m/sec	25,0 m/sec	25,0 m/sec	20,0 m/sec	25,0 m/sec
Guy line	2,5 mm, Polyester with Aluminium Peanut Sliders			2,5 mm Nylon with Aluminium Triangular Sliders	
Poles	Aluminium	Aluminium	Aluminium	Aluminium DAC Featherlike NSL, Green Anodized	Aluminium DAC Featherlike NSL, Green Anodized
Pegs	Aluminium Square Skewer	Aluminium Square Skewer	Aluminium Square Skewer	Aluminium Y-Pegs	Aluminium Y-Pegs
Available extras	Spare poles, Footprint	Spare poles, Footprint	Spare poles, Footprint	Spare poles, Footprint	Spare poles, Footprint

Svalbard 1

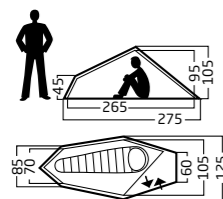

Otra 2

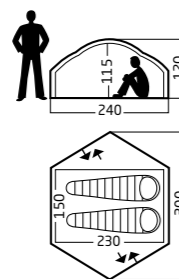

Telemark 2.2

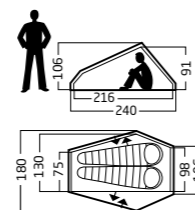

Halland 2

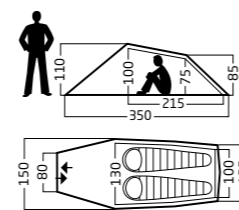

Oppland 2

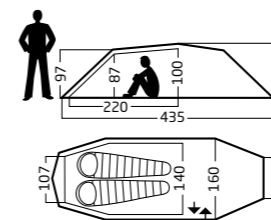

Oppland 3

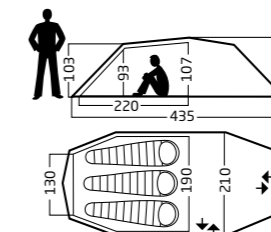

Oppland 4

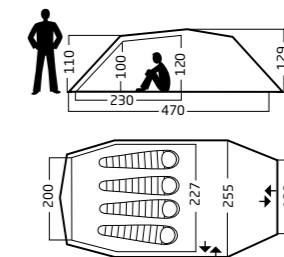

Tent overview - Addiction



ADDITION	Lofoten 1 ULW	Lofoten 2 ULW	Telemark 2.2 LW	Telemark 1 LW	Telemark 2.0 LW	Telemark 2 LW
Item no. / colour	151017 / Forest Green 151018 / Burnt Red	151020 / Forest Green 151021 / Burnt Red	151024 / Forest Green 151025 / Burnt Red	151010 / Forest Green 151012 / Burnt Red	10921040/ Whisper White	151006 / Forest Green 151008 / Burnt Red
Persons	1	2	2	1	2	2
Measurements flysheet	250 x 125 x 80 cm	250 x 125 x 80 cm	240 x 180 x 106 cm	240 x 148 x 96 cm	240 x 180 x 106 cm	240 x 180 x 106 cm
Measurements inner tent	220 x 85 x 70 cm	220 x 120 x 70 cm	216 x 130 x 91 cm	216 x 98 x 82 cm	214 x 130 x 91 cm	216 x 130 x 91 cm
Material flysheet	100% Nylon, Rip-stop, 7D		100% Nylon, Rip-stop, 10D			
Material inner tent	100% Nylon, 15D		100% Nylon, Rip-stop, 15D			
Material groundsheet	100% Nylon, 15D		100% Nylon, Rip-stop, 20D			
Water column fly	1600 mm		2000 mm			
Water column ground	3500 mm		8000 mm			
Trim weight	520 g	540 g	1.000 g	720 g	920 g	790 g
Net weight	560 g	590 g	1.080 g	890 g	1000 g	1000 g
Pack size	11 x 22 cm	11 x 22 cm	13 x 41 cm	12 x 41 cm	12 x 41 cm	12 x 41 cm
Windtest m/sec.	-	-	17,5 m/sec	25,0 m/sec	17,5 m/sec	17,5 m/sec
Guy line	1.2 mm Dyneema		2 mm Dyneema			
Poles	ULW Lite, Aluminium	ULW Lite, Aluminium	Aluminium DAC Featherlite NFL, Green Anodized			
Pegs	Titanium Tooth Peg Aluminium Triple Twister		Aluminium Triple Twister Peg			
Available extras	Inner cabin, Spare poles, Footprint	Inner cabin, Spare poles, Footprint	Spare poles, Footprint	Spare poles, Footprint	Spare poles, Footprint	Spare poles, Footprint



ADDITION	Halland 2 LW	Oppland 2 LW	Oppland 3 LW
Item no. / colour	151015 / Forest Green 151016 / Burnt Red	151022 / Forest Green 151023 / Burnt Red	151013 / Forest Green 151014 / Burnt Red
Persons	2	2	3
Measurements flysheet	365 x 160 x 110 cm	430 x 165 x 110 cm	430 x 210 x 120 cm
Measurements inner tent	215 x 135 x 100 cm	220 x 145 x 100 cm	225 x 190 x 110 cm
Material flysheet	100% Nylon, Rip-stop, 10D		100% Nylon, Rip-stop, 10D
Material inner tent	100% Nylon, Rip-stop, 15D		100% Nylon, Rip-stop, 15D
Material groundsheet	100% Nylon, Rip-stop, 20D		100% Nylon, Rip-stop, 20D
Water column fly	2000 mm		2000 mm
Water column ground	8000 mm		8000 mm
Trim weight	1.360 g	1.600 g	2.090 g
Total weight	1.440 g	1.700 g	2.080 g
Pack size	14 x 35 cm	13 x 40 cm	13 x 48 cm
Windtest m/sec.	25,5 m/sec	20,0 m/sec	25 m/sec
Guy line	2 mm Dyneema	2 mm Dyneema with Aluminium Triangular Sliders	
Poles	Aluminium DAC Featherlike NSL, Green Anodized	Aluminium DAC Featherlike NSL, Green Anodized	Aluminium DAC Featherlike NSL, Green Anodized
Pegs	Aluminium Triple Twister	Aluminium Triple Twister	Aluminium Triple Twister
Available extras	Spare poles, Footprint	Spare poles, Footprint	Spare poles, Footprint

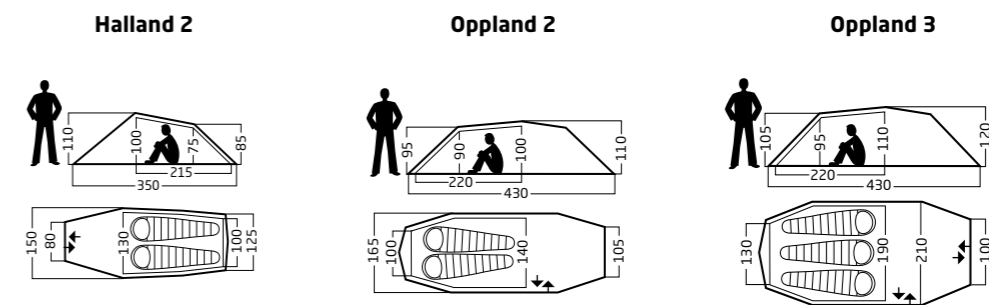
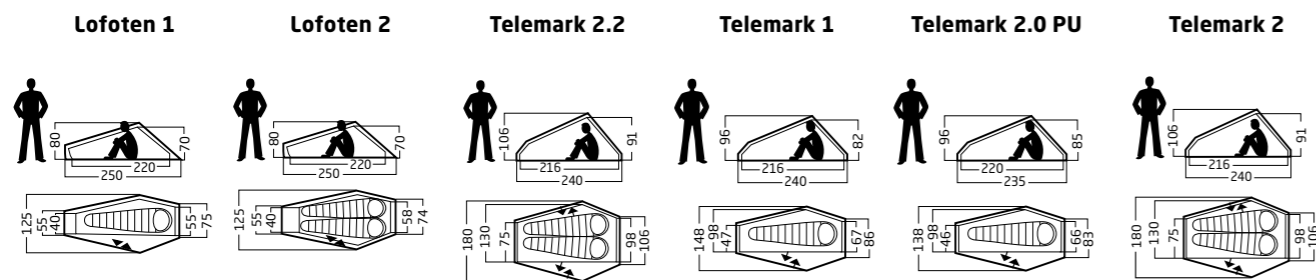

Tarp overview



SPIRIT	Kari Mini	Kari 8 m ²	Kari 12 m ² (2.0)	Kari 20 m ² (2.0)	Kari 30 m ²	Kari 41 m ²	Kari Diamond 10 m ² (2.0)	Kari Diamond 20 m ² (2.0)
Item no.	148062	142035	142038	142039	142036	142037	142040 / Sandshell	142041 / Sandshell
Colour	Sandshell	Sandshell						
Measurements	300 x 250 cm	250 x 325 cm	300 x 400 cm	400 x 500 cm	500 x 600 cm	550 x 750 cm	400 x 510 cm	585 x 750 cm
Material	Technical Cotton, 65% Polyester, 35% Cotton							
Water column	350 mm							
Net weight	1900 g		8.600 g	10.900 g				
Total weight	2000 g	8.000 g	9.100 g	11.400 g	13.200 g	17.500 g	6.500 g	9.900 g
Pack size	6 x 50 x 20 cm	21 x 60 cm	15 x 78 cm	18 x 78 cm	22 x 75 cm	23 x 80 cm	14 x 87 cm	17 x 79 cm
Guy line	High Tenacity Polyester 5.0 mm with Aluminium Triangular Slider							
Poles	Steel - 2 pieces		Steel - 2 pieces		Steel - 3 pcs		Steel - 2 pieces	
Pegs	Steel V-Peg - 10 pcs		Steel V-Peg - 12 pieces		Steel V-Peg - 14 pieces		Steel V-Peg - 8 pieces	

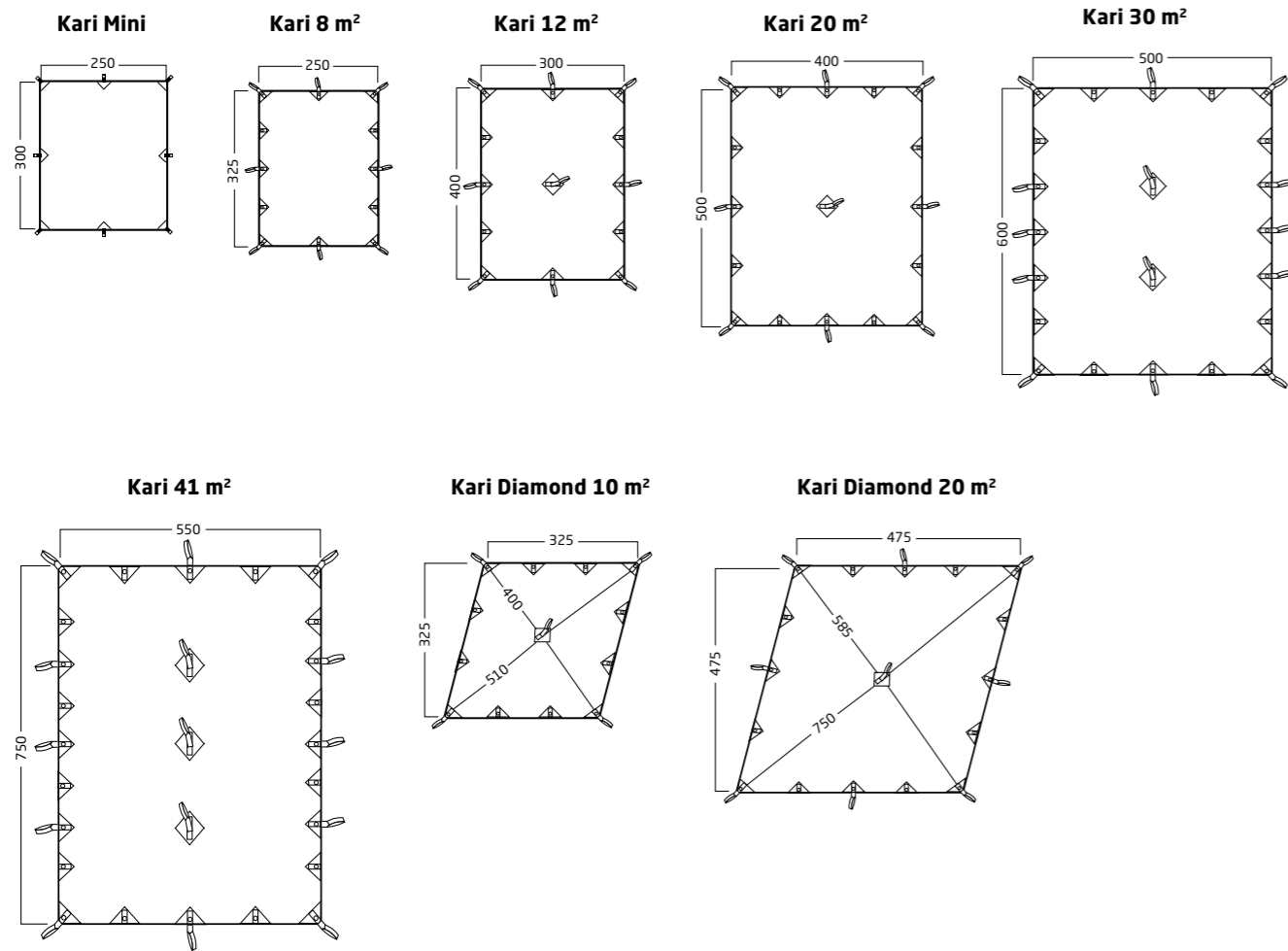

AMBITION	Voss 9 m ² SI	Voss 14 m ² SI	Voss 20 m ² SI	Voss Tentwing SI	Voss Tech
Item no. / colour	117011 / Forest Green	117012 / Forest Green	117013 / Forest Green	117014 / Forest Green	127023 / Dark Moss
Measurements	310 x 285 cm	430 x 320 cm	460 x 430 cm	300 x 310 cm	260 x 220 cm
Material	100% Nylon, Rip-stop				100% Nylon, Rip-stop, 68D
Water column	3000 mm				2000 mm
Net weight	800 g	1.100 g	1.550 g	500 g	1.100 g
Total weight	850 g	1.150 g	1.600 g	550 g	1.450 g
Pack size	22 x 30 cm	22 x 30 cm	28 x 34 cm	24 x 36 cm	15 x 20 x 8 cm
Guy line	2.5 mm Polyester with Triangular Lock Sliders				Sold separately
Poles	Sold separately				Sold separately
Pegs	Sold separately				Sold separately

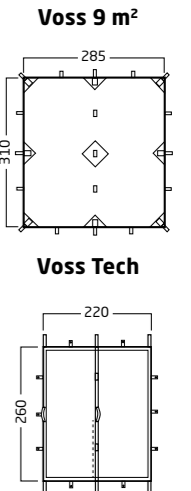

AMBITION	Voss 9 m ² PU	Voss 14 m ² PU	Voss 20 m ² PU	Voss Tentwing PU
Item no. / colour	127019 / Dark Olive	127020 / Dark Olive	127021 / Dark Olive	127022 / Dark Olive
Measurements	310 x 285 cm	430 x 320 cm	460 x 430 cm	300 x 310 cm
Material	100% Polyester, Rip-stop, PU			
Water column	3000 mm			
Net weight	1.050 g	1.500 g	2.050 g	700 g
Total weight	1.100 g	1.550 g	2.100 g	750 g
Pack size	20 x 33 cm	22 x 35 cm	24 x 33 cm	22 x 35 cm
Guy line	2.5 mm Polyester with Aluminium Peanut Sliders			
Poles	Sold separately			
Pegs	Sold separately			

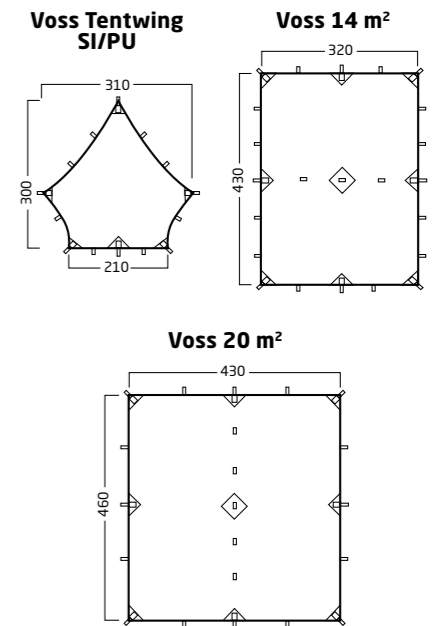

ADDITION	Voss 2 LW Tentwing	Voss 5 LW	Voss 7 LW Multi tarp
Item no. / colour	117023 / Forest Green	117015 / Forest Green	117022 / Forest Green
Measurements	184 x 230 cm	250 x 200 cm	380 x 220 cm
Material	100% Nylon, Rip-stop, 10D SI	100% Nylon, Rip-stop, 10D	100% Nylon 10D, Rip-stop, double sided 3 layer siliconized
Water column	2000 mm	2000 mm	2000 mm
Trim weight	100 g	180 g	250 g
Net weight	130 g	240 g	330 g
Pack size	10 x 10 cm	18 x 10 cm	12 x 20 cm
Lines	2,0 mm Dyneema, with sliders and hooks		
Poles	Sold separately	Sold separately	Sold separately
Pegs	Included	Sold separately	Sold separately

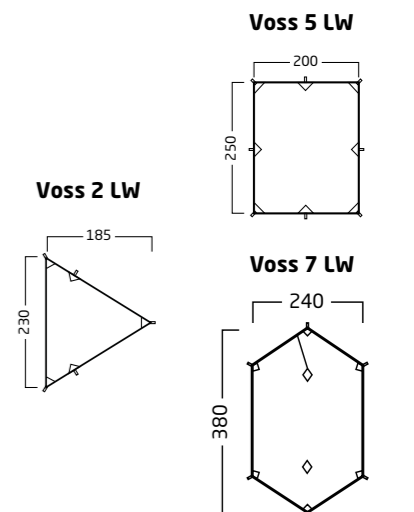

Summer

3-season

Winter

Extreme

SPIRIT



Puk +4 Egg Puk +10 Blanket Puk Junior



Almond +10 Tension Brick 200



Puk Scout Puk -2 Blanket Tension Mummy 300 Tension Mummy 500



Tension Brick 400 Tension Comfort 300 Voyage 300 Almond -2 Tension Junior



Voyage 500 Tension Comfort 600 Tension Comfort 800 Tension Brick 600

AMBI
TION



Passion One V.I.B 250



Gormsson +4 Curcve Gormsson +10 Curcve Puk +10 Curcve



Passion Three Puk -2 Curcve



Gormsson -2 Egg Gormsson -2 Curcve Gormsson -2 Mummy



Passion Five Balance 400 Balance 600 Puk -10 Mummy



Gormsson -10 Mummy V.I.B 400 V.I.B 600 V.I.B 800



Gormsson -20 Mummy

AD
DIC
TION



Phantom 220 Fever Ultra Oscar +10 Curcve Oscar +10 Mummy



Oscar -2 Curcve



Phantom 440 Phantom 770 Oscar -10 Mummy Oscar -20 Mummy



Arctic 1100 Arctic 1400

Sleeping Bag Overview - Spirit



SPIRIT	Voyage 300			Voyage 500			Tension Comfort 300			Tension Comfort 600			Tension Comfort 800		
Size	M	L	XL	M	L	XL	M	L	XL	M	L	XL	M	L	XL
Body length up to	175	190	205	175	190	205	175	190	205	175	190	205	175	190	205
Item no. (L zip)	82721	82731	82741	82821	82831	82841	84221	84231	84241	84321	84331	84341	84421	84431	84441
Filling	Down			Down			Down			Down			Down		
Net weight (g)	800	900	1.000	1.000	1.100	1.200	790	840	870	1.100	1.200	1.260	1.250	1.400	1.460
Total weight (g)	900	1000	1.100	1.100	1.200	1.300									
Filling (g)	270	300	315	445	500	520	260	300	310	540	600	620	735	800	830
Width (cm)	74-94/49	77-97/50	77-97/50	74-94/49	77-97/50	77-97/50	90/55	93/57	93/57	90/55	93/57	93/57	90/55	93/57	93/57
Season	3-season			Winter			3-season			Winter			Winter		
Temperature	+6°C +1°C -14°C			0°C -5°C -22°C			+8°C +3°C -10°C			+3°C -3°C -20°C			-1°C -6°C -23°C		
Pack size (cm)	20 x 28			22 x 30			31 x 20 / compressed 25 x 20			34 x 20 / compressed 28 x 20			35 x 20 / compressed 30 x 20		
Construction	H-Box			H-Box			H-Box			H-Box			H-Box		
Zipper	Side Zip			Side Zip			Complete Zip			Complete Zip			Complete Zip		



SPIRIT	Puk +10° Blanket		Puk -2° Blanket		Puk +4° Egg		Almond +10°		Almond -2°	
Size	M	L	M	L	M	L	S	L	S	L
Body length up to	175	190	175	190	175	190	160	190	160	190
Item no. (L zip)	110344	110345	110346	110347	110348	110349	141009	141004	141010	141003
Filling	Fibre		Fibre		Fibre		Fibre	Fibre	Fibre	Fibre
Net weight (g)	650	760	1.530	1.740	805	930	1.100	1.500	1.500	2.000
Total weight (g)							1.200	1.600	1.600	2.100
Filling (g)	215	240	680	760	310	400	140	200	450 g	650
Width (cm)	75/75	80/80	75/75	80/80	82/64	85/65	70/70	85/85	70/70	85/85
Season	Summer		3-season		Summer		Summer		3-season	
Temperature	+15°C +10°C -2°C		+5°C -2°C -18°C		+9°C +4°C -8°C		+13°C +10°C -3°C		+3°C -2°C -19°C	
Pack size (cm)	15 x 27	15 x 29	21 x 36	22 x 39	18 x 29	19 x 30	14 x 32 x 30 cm	15 x 35 x 31 cm	18 x 44 x 30 cm	23 x 44 x 35 cm
Construction	Stitched Through Non-stitched lining		Offset Double Box		Stitched Through Non-stitched lining		Stitched Through		Stitched Through	
Zipper	Complete Zip		Complete Zip		Complete Zip		Complete Zip		Complete Zip	



SPIRIT	Tension Mummy 300			Tension Mummy 500			Tension Brick 200			Tension Brick 400			Tension Brick 600		
Size	M	L	XL	M	L	XL	M	L	XL	M	L	XL	M	L	XL
Body length up to	175	190	205	175	190	205	175	190	205	175	190	205	175	190	205
Item no. (R zip)	84020	84030	-	84120	84130	-	-	-	-	-	-	-	-	-	-
Item no. (L zip)	84021	84031	84041	84121	84131	84141	84521	84531	84541	84621	84631	84641	84721	84731	84741
Filling	Down			Down			Down			Down			Down		
Net weight (g)	700	800	900	900	1.000	1.100	700	600	800	900	1.000	1.100	1.090	1.210	1.300
Total weight (g)	800	900	1000	1.000	1.100	1.200	800	700	900	1.000	1.100	1.200			
Filling (g)	270	300	315	440	500	520	170	200	210	355	400	445	545	600	650
Width (cm)	7/50	80/53	80/53	77/50	80/53	80/53	77/77	81/81	81/81	77/77	81/81	81/81	77/77	81/81	81/81
Season	3-season			3-season			Summer			3-season			Winter		
Temperature	+6°C +1°C -15°C			+3°C -2°C -18°C			+16°C +13°C +4°C			+5°C -1°C -16°C			+2°C -4°C -20°C		
Pack size (cm)	28 x 16 / compressed 22 x 16			30 x 16 / compressed 24 x 16			26 x 20 / compressed 20 x 20			29 x 20 / compressed 23 x 20			30 x 20 / compressed 24 x 20		
Construction	H-Box			H-Box			Stitched through			H-Box			H-Box		
Zipper	Side Zip			Side Zip			Complete Zip			Complete Zip			Complete Zip		



SPIRIT	Puk Junior		Puk Scout		Tension Junior	
Size	Junior		Junior		Junior	
Body length up to	170		170		160	
Item no.	110350 Sun-dried Tomato / Majolica Blue		110351 Sun-dried Tomato / Majolica Blue		84821	
Filling	Fibre		Fibre		Down	
Net weight (g)	760		1080		680	
Filling (g)	330		810		300	
Width (cm)	68/45		68/45		66/49(46)	
Season	Summer		3-season		3-season	
Temperature *	approx. +11° to +7°		approx. +7° to +3°		approx. +10° to +14°	
Pack size (cm)	20 x 26,5		22 x 28		27 x 16 cm	
Construction	Stitched Through		Offset Double Box		H-Box	
Zipper	Side Zip		Side Zip		Complete Zip	

GREAT AND INDISPENSABLE ACCESSORIES FOR YOUR SLEEPING BAG



Cotton Liner Blanket
Item no. 106004



Organic cotton storage pouch
Item no. 106010



Storage bag
Item no. 0660 / 0661

*Standard temperature testing according to EN13537 is not applicable for children's sleeping bags. For tiny tots and young adventurers we therefore provide a NORDISK temperature range recommendation that takes into account the subjective sensation of cold, depending on age, physique and activity level.

Sleeping Bag Overview - Ambition



AMBITION	Passion One			Passion Three			Passion Five			Balance 400			Balance 600		
Size	M	L	XL	M	L	XL	M	L	XL	M	L	XL	M	L	XL
Body length up to	175	190	205	175	190	205	175	190	205	175	190	205	175	190	205
Item no. (L zip)	87021	87031	87041	87121	87131	87141	87221	87231	87241	85021	85031	85041	85121	85131	85141
Filling	Down			Down			Down			Down			Down		
Net weight (g)	300	350	350	500	550	600	650	750	850	800	850	1.000	900	1.000	1.150
Total weight (g)	350	400	450	550	600	650	700	850	950	850	950	1.050	1.050	1.150	1.250
Filling (g)	100	125	130	260	290	305	440	495	515	350	400	440	540	600	650
Width (cm)	77/52	83/54	83/54	77/52	83/54	83/54	75/52	80/56	80/56	75/49	77/50	79/51	75/49	77/50	79/51
Season	Summer			3-season			Winter			Winter			Winter		
Temperature	+15°C +12°C -1°C			+7°C +3°C -10°C			-2°C -7°C -25°C			+3°C -3°C -19°C			-2°C -8°C -26°C		
Pack size (cm)	21 x 12			27 x 14			37 x 14			33 x 22 / compressed 27 x 22			35 x 23 / compressed 29 x 23		
Construction	Stitched through			H-Box			S-Box			H-Box			H-Box		
Zipper	Side Zip			Side Zip			Side Zip			Side Zip			Side Zip		



AMBITION	V.I.B 250			V.I.B 400			V.I.B 600			V.I.B 800		
Size	M	L	XL	M	L	XL	M	L	XL	M	L	XL
Body length up to	175	190	205	175	190	205	175	190	205	175	190	205
Item no. (L zip)	86021	86031	86041	86121	86131	86141	86221	86231	86241	86321	86331	86341
Filling	Down			Down			Down			Down		
Net weight (g)	600	650	700	800	850	900	1.050	1.100	1.150	1.150	1.400	1.650
Total weight (g)	650	700	750	900	950	1.000	1.150	1.250	1.300	1.300	1.550	1.750
Filling (g)	230	260	270	345	400	415	530	605	635	700	800	835
Width (cm)	77/52	80/54	80/54	77/52	80/54	80/54	77/54	80/56	80/56	79/54	83/56	83/56
Season	Summer			Winter			Winter			Winter		
Temperature	+10°C +6°C -8°C			+3°C -2°C -18°C			0°C -5°C -22°C			-6°C -13°C -32°C		
Pack size (cm)	29 x 16 / compressed 23 x 16			31 x 19 / compressed 26 x 19			34 x 22 / compressed 29 x 22			37 x 25 / compressed 31 x 25		
Construction	H-Box			S-Box			S-Box			S-Box		
Zipper	Side Zip			Side Zip			Side Zip			Side Zip		



AMBITION	Puk +10 Curve			Puk -2 Curve			Puk -10 Mummy			Gormsson +10 Curve			Gormsson +4 Curve		
Size	M	L	XL	M	L	XL	M	L	XL	M	L	XL	M	L	XL
Body length up to	175	190	205	175	190	205	175	190	205	175	190	205	175	190	205
Item no. (L zip)	110331	110332	110333	110338	110339	110340	110328	110329	110330	110461	110462	110463	110464	110465	110466
Filling	Fibre			Fibre			Fibre			Fibre			Fibre		
Net weight (g)	550	600	650	1.200	1.300	1.400	1.640	1.850	2.250	500	550	600	650	700	750
Total weight (g)	600	650	750	1.300	1.400	1.500	1.750	1.950	2.400	550	600	650	750	800	850
Filling (g)	200	220	240	780	880	930	1.470	1.600	1.750	180	200	225	315	340	370
Width (cm)	74/54	77/55	80/56	74/54	77/55	80/56	74/54	77/55	80/56	74/54	77/55	80/56	74/54	77/55	80/56
Season	Summer			3-season			Winter			Summer			Summer		
Temperature	+15°C +10°C -2°C			+5°C -2°C -18°C			-5°C -10°C -20°C			+14°C +10°C -2°C			+9°C +4°C -10°C		
Pack size (cm)	15 x 23	16 x 24	17 x 27	24 x 32	24 x 33	24 x 36	28 x 36	28 x 38	28 x 40	16 x 20	16 x 22	16 x 24	17 x 23	17 x 25	17 x 28
Construction	Stitched Through Non-stitched lining			Stitched Through Non-stitched lining			Offset Double Box			Stitched Through			Stitched Through		
Zipper	Complete Zip			Complete Zip			Side Zip			Complete Zip			Side Zip		



AMBITION	Gormsson -2 Curve			Gormsson -2 Egg		Gormsson -2 Mummy				Gormsson -10 Mummy			Gormsson -20 Mummy		
Size	M	L	XL	L	XL	S	M	L	XL	M	L	XL	M	L	XL
Body length up to	175	190	205	190	205	160	175	190	205	175	190	205	175	190	205
Item no. (L zip)	110467	110468	110469	110474	110475	110484	110470	110471	110472	110460	110444	110445	110459	110446	110447
Filling	Fibre			Fibre		Fibre				Fibre			Fibre		
Net weight (g)	1.100	1.150	1.250	1.300	1.450	1.050	1.100	1.150	1.250	1.650	1.750	1.850			
Total weight (g)	1.200	1.250	1.350	1.450	1.600	1.100	1.200	1.250	1.350	1.750	1.900	2.000	2.030	2.180	2.380
Filling (g)	670	730	800	850	920	650	680	710	780	1.220	1.290	1.380	1.600	1.700	1.800
Width (cm)	74/54	77/55	80/56	85/65	88/66	69/53	71/54	73/55	76/56	71/54	73/55	76/56	71/54	73/55	76/56
Season	3-season			3-season		3-season				Winter			Extreme		
Temperature	+4°C -2°C -20°C			+4°C -2°C -20°C		+4°C -2°C -20°C				-6°C -10°C -30°C			-10°C -20°C -40°C		
Pack size (cm)	21 x 28	21 x 31	21 x 34	21 x 31	21 x 34	26 x 26	21 x 27	21 x 30	21 x 33	25 x 33	25 x 35	25 x 38	28 x 38	28 x 40	28 x 43
Construction	Offset Double Box			Offset Double Box		Offset Double Box				Offset Double Box			Offset Triple Box		
Zipper	Side Zip			Side Zip		Side Zip				Side Zip			Side Zip		

Sleeping Bag Overview - Addiction



ADDITION	Arctic 1100			Arctic 1400			Phantom 220			Phantom 440			Phantom 770		
Size	M	L	XL	M	L	XL	M	L	XL	M	L	XL	M	L	XL
Body length up to	175	190	205	175	190	205	175	190	205	175	190	205	175	190	205
Item no. (L zip)	77621	77631	77641	77721	77731	77741	82921	82931	82941	83021	83031	83041	83121	83131	83141
Filling	Down			Down			Down			Down			Down		
Trim weight (g)	1.750	1.830	1.950	280	290	310	550	640	660	840	890	950	1.210	1.320	1.410
Net weight (g)	1.750	1.850	1.950	280	290	310	550	640	660	840	890	950	1.210	1.320	1.410
Filling (g)	975	1.100	1.170	1.210	1.400	1.520	190	220	230	385	440	465	700	770	805
Width (cm)	85/55	88/57	88/57	85/55	88/57	88/57	73/44	75/45	75/45	73/44	75/45	75/45	75/45	77/46	77/46
Season	Extreme			Extreme			Summer			Winter			Winter		
Temperature	-10°C -18°C -38°C			-20°C -28°C -48°C			+11°C +7°C -5°C			+2°C -4°C -20°C			-2°C -9°C -27°C		
Pack size (cm)	43 x 31 / compressed 37 x 31			48 x 35 / compressed 42 x 35			26 x 16 / compressed 20 x 16			31 x 20 / compressed 26 x 20			37 x 24 / compressed 31 x 24		
Construction	H+S-Box			H+S-Box			S-Box / Stitched through			S-Box			S-Box		
Zipper	Side Zip			Side Zip			Side Zip			Side Zip			Side Zip		





ADDITION	Oscar +10 Curve		Oscar +10 Mummy		Oscar -2 Curve			Oscar -10 Mummy			Oscar -20 Mummy			Fever Ultra		
Size	M	L	M	L	M	L	XL	M	L	XL	M	L	XL	M	L	XL
Body length up to	175	190	175	190	175	190	205	175	190	205	175	190	205	175	190	205
Item no. (L zip)	110476	110477	110482	110483	110479	110480	110481	110453	110454	110455	110458	110456	110457	81921	81931	81941
Filling	Fibre		Fibre		Fibre			Fibre			Fibre			Down		
Trim weight (g)	320	350	330	390	750	880	950	1.610	1.720	1.850	1.890	2.090	2.290	280	290	310
Net weight (g)	320	350	330	390	750	880	950	1.610	1.720	1.850	1.890	2.090	2.290	280	290	310
Filling (g)	125	140	105	120	450	510	570	700	750	800	1.050	1.090	1.130	100	125	130
Width (cm)	74/54	77/55	71/54	73/55	74/54	77/55	80/56	71/54	73/55	76/56	71/54	73/55	76/56	73/44	75/45	75/45
Season	Summer		Summer		3-season			Winter			Winter			Summer		
Temperature	+14°C +10°C -2°C		+14°C +10°C -2°C		+4°C -2°C -20°C			-6°C -10°C -30°C			-10°C -20°C -40°C			+13°C +9°C -2°C		
Pack size (cm)	14 x 21	14 x 22	14 x 20	14 x 21	19 x 28	19 x 30	19 x 33	25 x 34	25 x 36	25 x 38	27 x 36	27 x 38	27 x 40	18 x 11		
Construction	Stitched Through		Stitched Through		Offset Double Box			Tubic			Tubic			Stitched Through		
Zipper	Half Side Zip		Half Side Zip		Side Zip			Side Zip			Side Zip			Side Zip		







Mats Overview

					
SPIRIT	Alden 5.0 S	Alden 5.0 M	Alden 5.0 L	Alden 10.0 XL	Alden 5.0 Cushion
Measurements	168 x 51 x 5 cm	183 x 55 x 5 cm	198 x 77 x 5 cm	198 x 77 x 10	43 x 30 x 5 cm
Material front	20D Stretch Polyester, 100% Polyester	20D Stretch Polyester, 100% Polyester	20D Stretch Polyester, 100% Polyester	20D Stretch Polyester, 100% Polyester	20D Stretch Polyester, 100% Polyester
Material back	20D Stretch Polyester, 100% Polyester	20D Stretch Polyester, 100% Polyester	20D Stretch Polyester, 100% Polyester	20D Stretch Polyester, 100% Polyester	20D Stretch Polyester, 100% Polyester
Net weight	1.100 g	1.400 g	1.800 g	2.700 g	200 g
Pack size	16 x 26 cm	18 x 34 cm	20 x 39 cm	28 x 42 cm	9,5 x 17,5 cm
Foam	16 kg/m ³ PU	16 kg/m ³ PU	16 kg/m ³ PU	16 kg/m ³ PU	16 kg/m ³ PU
R-Value	3,7	3,7	3,7	6,0	3,7
Colour	Reflective Pond / Sandshell	Reflective Pond / Sandshell	Reflective Pond / Sandshell	Reflective Pond / Sandshell	Reflective Pond / Sandshell
Item no.	114046	114048	114050	114052	114044
Features	Self-inflatable	Self-inflatable	Self-inflatable	Self-inflatable	Self-inflatable

			
AMBITION	Vega	Vanna 2.5	Vanna 3.8
Measurements	180 x 50 x 7,5 cm	183 x 51 x 2,5 cm	183 x 51 x 3,8 cm
Material front	100% Polyester, 20D	100% Polyester, 20D	100% Polyester, 20D
Material back	100% Polyester, 30D, anti-slip	100% Polyester, 20D	100% Polyester, 30D
Net weight	460 g	400 g	540 g
Pack size	8 x 22 cm	12 x 27 cm	14 x 27 cm
Foam	-	Hybrid, 12 kg/m ³ ultralight foam	Hybrid, 12 kg/m ³ ultralight foam
R-Value	-	2,3	3,6
Colour	Burnt Red / Black	Burnt Red / Black	Burnt Red / Black
Item no.	115005	115003	115004

					
ADDITION	Ven 2.5	Grip 2.5 R	Grip 2.5 L	Grip 3.8 R	Grip 3.8 L
Measurements	122 x 51 x 2,5 cm	178 x 50 x 2,5 cm	193 x 50 x 2,5 cm	178 x 50 x 3,8 cm	193 x 50 x 3,8 cm
Material front	100% Polyester, 20D	100% Polyester, 20D	100% Polyester, 20D	100% Polyester, 20D	100% Polyester, 20D
Material back	100% Polyester, 20D	100% Polyester, 20D	100% Polyester, 20D	100% Polyester, 30D, anti-slip	100% Polyester, 30D, anti-slip
Net weight	280 g	340 g	385 g	470 g	520 g
Pack size	10 x 28 cm	12 x 26 cm	13 x 26 cm	13 x 26 cm	15 x 26 cm
Foam	Hybrid, 12 kg/m ³ ultralight foam	Hybrid, 12 kg/m ³ ultralight foam	Hybrid, 12 kg/m ³ ultralight foam	Hybrid, 12 kg/m ³ ultralight foam	Hybrid, 12 kg/m ³ ultralight foam
R-Value	2,3	2,3	2,3	3,6	3,6
Colour	Mustard Yellow / Black	Mustard Yellow / Black	Mustard Yellow / Black	Mustard Yellow / Black	Mustard Yellow / Black
Item no.	115006	115007	115008	115009	115010

Retail Accessories



Inner Cabin Lofoten
1 /Item no. 107159
2 Item no. 107157

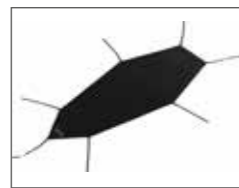

Footprint
Svalbard 1
Item no. 107093



Footprint
Halland 2
Item no. 107095



Footprint
Oppland 2
Item no. 10901015



Footprint
Oppland 3
Item no. 10901016



Aluminium Triple Twister
Set of 6
Item no. 119102



Aluminium Y-Peg
Set of 6
Item no. 119103



Stainless Steel Nail
Set of 6
20 cm. Item no. 119068



Stainless Steel Nail
Set of 4
30 cm. Item no. 119040

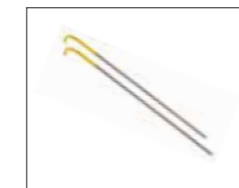

Tooth Peg
Set of 6
Item no. 119064



Footprint
Oppland 4
Item no. 10901017

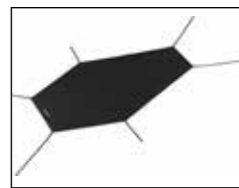

Footprint
Telemark 1
Item no. 107122

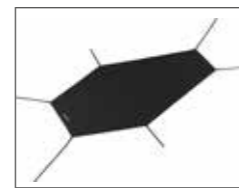

Footprint
Telemark 2 + .2.2
Item no. 107123



Footprint
Lofoten 1+2
Item no. 107156



Footprint
Reisa 4
Item no. 107096



V-Peg 9 g
Set of 2
Item no. 119036



V-Peg 15 g
Set of 2
Item no. 119035

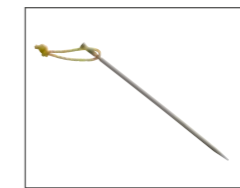

Titanium Nail 8 g
Set of 2
Item no. 107034

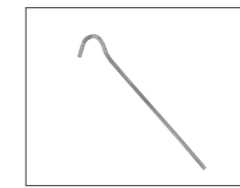

Steel Skewer
Set of 10
Item no. 119038



Steel T-Peg
Set of 2
Item no. 119037



Footprint
Reisa 6
Item no. 107097



Footprint
Thrymheim 3
Item no. 107258



Footprint
Thrymheim 5
Item no. 107257



Zip-in floor
Alfheim 12.6 m²
Item no. 146012
Alfheim 19.6 m²
Item no. 146013



Zip-in floor
Asgard 12.6 m² (2.0)
Item no. 146020
Asgard 19.6 m² (2.0)
Item no. 146021



Steel V-Peg
Set of 6
Item no. 119039



Guy Line 10 m
Dyneema 1.2 mm
Item no. 119108



Guy Line 15 m
Dyneema 2.0 mm
Item no. 119107



Guy Line 15 m
Nylon 2.5 mm
Item no. 119106



Guy Line 15 m
Polyester 2.5 mm
Item no. 119104



Zip-in floor
Utgard Sky 13.2
Item no. 146019



Zip-in floor
Vanaheim 24 m²
Item no. 146014
Vanaheim 40 m²
Item no. 146015



Aluminium Pole Set
Asgard 7.1 m²
Item no. 107173



Kari alu pole set
Adjustable (240-260 cm)
Set of 2
Item no. 107276



Aluminium Tarp Pole Set
Set of 2
Short: Item no. 107109
Long: Item no. 119056



Guy Line 15 m
Polyester 3.0 mm
Item no. 119105



Inner Cabin
Alfheim 12.6 m²
Item no. 144014



Inner Cabin
Alfheim 19.6 m²
Item no. 144013



Inner Cabin
Asgard 7.1 m²
Item no. 144012



Inner Cabin
Asgard 12.6 m²
Item no. 144011



Extendable Pole Aluminium
L: Item no. 119063
XL: Item no. 119065



Guy Line 3.5 mm
20 m
Item no. 119078



Guy Line 5.0 mm
20 m
Item no. 119048



Aluminium
Snow & Sand Peg
Set of 6
Item no. 119101



Aluminium Square Skewer
Set of 6
Item no. 119100



Inner Cabin set
Asgard 19.6 m²
Item no. 145021



Inner Cabin
Utgard 13.2 m²
Item no. 144010



Inner Cabin
Vanaheim 24 m²
Item no. 144016



Inner Cabin
Vanaheim 40 m²
Item no. 145022



Asgard Wall Extension
12.6 m². Item no. 147023
19.6 m². Item no. 147024

Spareparts



Cordstopper
Set of 12
Mix 6 mm / 8 mm hole
Item no. 119074



Legacy Cordstopper
Set of 20
Large Item no. 119077



Zipper puller
Drop Shape
Set of 10
Item no. 119075



Zipper puller
Thor's Hammer
Set of 10
Item no. 119076



Zipper puller
Item no. 806

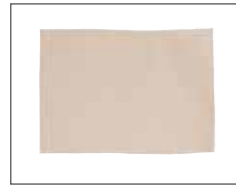

Legacy original adhesive
fabric patch TC
Item no. 803



Ceiling Storage Net
Polyester Mesh
Item no. 119051



Cotton liner
Blanket
Item no. 106004



Organic Cotton
storage pouch
Item no. 106010



Storage Bag
Item no. 0660 / 0661



Aluminium Peanut Slider
Set of 10
Item no. 119109



Aluminium Helmet Slide
Set of 8
20 mm. Item no. 119066



Aluminium Helmet Slide
Set of 6
25 mm. Item no. 119067



Triangular Lock Slider
Plastic
Set of 10
Item no. 119054



Triangular Slider
Set of 10
Item no. 119045



Spare Chimney Segments
Set of 2
Item no. 149040



Aluminium Hook
Set of 10
Small. Item no. 119079



Aluminium Hook
Set of 10
Large. Item no. 119080



Aluminium Hook
Set of 4
X-Large. Item no. 119069



Mini Hook
+ Silicone ring set
Set of 15
Item no. 119073



Sparepoles
Midgard 9.2 m²
Alu. Item no. 107167



Sparepoles
Midgard 20 m²
Alu. Item no. 107168



Hamarr replacement head
Item no. 109095



Sparepoles
Svalbard 1 PU
Item no. 107264



Sparepoles
Svalbard 1 SI
Item no. 107102



Sparepoles
Halland 2 PU
Item no. 107267



Sparepoles
Halland 2 LW
Item no. 107175



Sparepoles
Lofoten 1+2 ULW
Item no. 107158



Sparepoles
Oppland 2 PU
Item no. 10931018

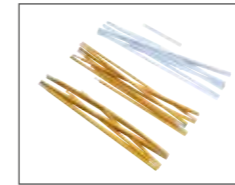

Sparepoles
Oppland 2 SI
Item no. 107139

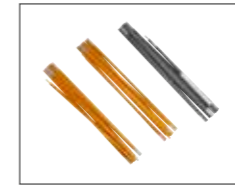

Sparepoles
Oppland 3 LW
Item no. 107160



Sparepoles
Otra 2 PU
Item no. 107268

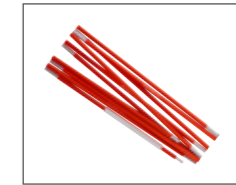

Sparepoles
Telemark 2.2 PU
Item no. 107263



Sparepoles
Oppland 3 PU
Item no. 10931019



Sparepoles
Oppland 3 SI
Item no. 107138



Sparepoles
Oppland 3 LW
Item no. 107142



Sparepoles
Oppland 4 PU
Item no. 10931020



Sparepoles
Telemark 1 LW
Item no. 107121



Sparepoles
Telemark 2 LW
Item no. 107119



Sparepoles
Telemark 2.2 LW
Item no. 107119



Sparepoles
Thrymheim 3
Item no. 107260



Sparepoles
Thrymheim 5
Item no. 107259



Canopy poles
Thrymheim 3/5
Item no. 107274



Sparepoles
Reisa 4 PU
Item no. 107261



Sparepoles
Reisa 6 PU
Item no. 107262



Sparepole A Frame
Midgard 9.2 m²
Steel. Item no. 10931026



Sparepole A Frame
Midgard 9.2 m²
Alu. Item no. 107278



Sparepole A Frame
Midgard 20 m²
Steel. Item no. 10931029



Sparepole A Frame
Midgard 20 m²
Alu. Item no. 107171

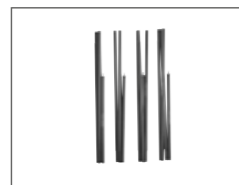

Sparepole small entrance
Midgard 9.2/20 m²
Steel. Item no. 10931030



Sparepole small entrance
Midgard 9.2/20 m²
Alu. Item no. 107281

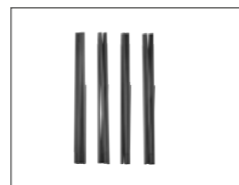

Sparepole large entrance
Midgard 9.2/20 m²
Steel. Item no. 10931031



Sparepole large entrance
Midgard 9.2/20 m²
Alu. Item no. 107277



Legacy velcro for zipper
flaps at door, 50 cm
Item no. 809



Sparepoles
Asgard Wall Extension
Item no. 107145



Elastic Guy Line
20 m
Item Item no. 801



Original YKK zipper slider
Set of 5
Item no. 814



Legacy compression webbing
20 mm. Item no. 820
25 mm. Item no. 822
38 mm. Item no. 823



Sparepoles Vimur 4.8 m²
Steel. Item no. 107165
Alu. Item no. 107169



Sparepoles Vimur 5.6 m²
Steel. Item no. 107166
Alu. Item no. 107170



Sparepoles
Vannaheim 24 m²
Item no. 107129



Sparepoles
Vannaheim 40 m²
Item no. 107130



Sparepoles
Ydun Sky 5.5 m²
Item no. 10931021



Legacy nylon webbing
Item no. 802



Legacy Webbing Loop
Item no. 815



Torden ember mat
Item no. 149033



Torden Wooden Box
Item no. 149024



Torden wood burner bag
Item no. 149031



Sparepoles
Utgard Sky 13.2 m²
Item no. 10931022



Sparepoles
Alfheim 12.6 m²
Item no. 107124



Sparepoles
Alfheim 19.6 m²
Item no. 107125



Sparepoles
Asgard 7.1 m² (2.0)
Item no. 10931023



Sparepoles
Asgard 12.6 m² (3.0)
Item no. 10931024



Pipe Spark Arrest Segment
Item no. 149048



Pipe Elbow Segment
Item no. 149049

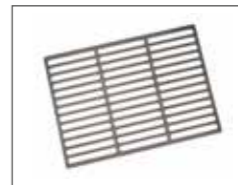

Torden Grate
Item no. 149045



Torden Ashtray
Item no. 149046



Torden Base Set
Item no. 149042



Sparepoles
Asgard 19.6 m² (3.0)
Item no. 10931025



Sparepole Set, Kari
190-230 cm, set of 2
Item no. 107282



Sparepole Set, Kari
230-260 cm, set of 2
Item no. 107283



Legacy original fabric
roll TC
Item no. 840



Legacy original mosquito
mesh, 10 m
Item no. 807



Torden spare glass
Set of 3
(1 front + 2 side)
Item no. 149041

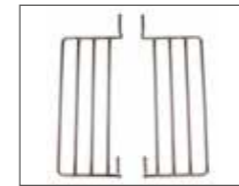

Torden Stainless Steel
Wings
Item no. 149043



Door handles set of 2
Item no. 149044



Exit Pipe Set
Item no. 149047



Flysheetsacks
Utgard 13.2 m²
Item no. 836



Flysheetsacks
Alfheim 19.6 m²
Item no. 834
Alfheim 19.6 m²
Item no. 835



Flysheetsacks
Vanaheim 24 m²
Item no. 837
Vanaheim 40 m²
Item no. 838



Flysheetsacks
Ydun 5.5 m²
Item no. 839



Flysheetsacks
Asgard 7.1 m² Item no. 831
Asgard 12.6 m² Item no. 832
Asgard 19.6 m² Item no. 833



Cabin Packsack
M: Item no. 842
L: Item no. 843



Zip-in-floor Bag
S: Item no. 824
M: Item no. 825
L: Item no. 826
XL: Item no. 827



Peg Bag
Item no. 817



Pole Bag
Item no. 818



Tarp Packsack
Kari 12. Item no. 828
Kari 20. Item no. 829
Kari Diamond. Item no. 830



DENMARK

Nordisk Company A/S
Papirfabrikken 74
DK-8600 Silkeborg
+45 7373 4000
info@nordisk.eu

GERMANY

Nordisk Freizeit GmbH
Max-Weber-Strasse 16
DE-25451 Quickborn
+49 (0) 4106 76770
info@nordisk.de

Nordisk Freizeit GmbH
Die Manufaktur
Rauschwalder Str. 42/43
DE-02826 Görlitz
Tel. +49 3581 76560
info@nordisk.de

JAPAN

Nordisk Japan Co., Ltd.
Greenland Aoyama Bldg. III 301, 6-6-22,
Minami-Aoyama, Minato-ku,
Tokyo 107-0062, Japan
+81(0) 3 6885 8206
info@nordisk.co.jp

CHINA

Nordisk Asia Ltd.
Unit 904, Zhong Rong
Heng Rui West Tower
560 Zhang Yang Road
CN-200122 Shanghai
+86 13901625206
asia@nordisk.eu

ARGENTINA

Eve Group
José Antonio Cabrera 6027
AR-C1414 BHM Buenos Aires
+54 11 5252 5900
jacobo@evegroup.co

BELGIUM

Elements BVBA
Boerenlegerstraat 230
BE-2650 Edegem
+32 475 69 04 06
info@elementsbvba.be

FINLAND

Nordisk Company A/S
Papirfabrikken 74
DK-8600 Silkeborg
+45 7373 4000
info@nordisk.eu

LUXEMBOURG

Elements BVBA
Boerenlegerstraat 230
BE-2650 Edegem
+32 475 69 04 06
info@elementsbvba.be

PAKISTAN

Symbolic
#403, 4th Floor, The Plaza, Block 9
Clifton
PK-75600 Karachi Clifton
sahmed@symbolic.pk

SLOVENIA

Factory Store d.o.o
Grinze 125
SI-3302 Grinze
+386(0)37103686
janez@factorystore.si

SWEDEN

Nordisk Company A/S
Papirfabrikken 74
DK-8600 Silkeborg
+45 7373 4000
info@nordisk.eu

UK AND IRELAND

Ark Consultants UK Ltd
Lowbrook Barn, Lancaster Road
GB-LA2 6AL Lancaster
+44 1524 822084
sales@arkconsultants.co.uk

AUSTRIA

Nordisk Freizeit GmbH
Max-Weber-Strasse 16
DE-25451 Quickborn
+49 (0) 4106 76770
info@nordisk.eu

CZECH REPUBLIC

Prosport Praha s.r.o.
Ke Mlýnu 1
CZ-149 00 Praha 4 - Ujezd
+420 241 483 338
prosport@prosport.cz

FRANCE

Sports Alpins Distribution
1051 Avenue André Lasquin,
74700 Sallanches
+33 04 50 58 45 82
contact@sad-chamonix.fr

NETHERLANDS

Outware Trading
Industriestraat 9
NL-5953 Reuver
+31(0)6 21858327
rob@outware.eu

POLAND

Polish Outdoor
Distribution Group Sp. z o.o.
Skalny Widok 4D
PL-42-421 Hucisko
+48 669 514 652
kontakt@podg.pl

SOUTH KOREA

Synkey Group Inc
Dong Ah Bldg. 7F, 7 Gukhoe-daero 70-gil
Yeongdeungpo-gu
KR-07238 Seoul
+82-2-784-7800
ylah@synkey.com

SWITZERLAND

Nordisk Freizeit GmbH
Max-Weber-Strasse 16
DE-25451 Quickborn
+49 (0) 4106 76770
info@nordisk.eu

BALTIKUM

Nordisk Company A/S
Papirfabrikken 74
DK-8600 Silkeborg
+45 7373 4000
info@nordisk.eu

DUBAI

Times Square FZE
PO Box 118238
Jafza
AE-00000 Dubai
+971 45179888
joanna@tsdubai.com

ITALY

Peg & Cloth SAS
Via Are 206/C
I - 37026
Pescantina (VR)
Email: info@pegandco.com
Phone: (0039)3488324040

NORGE

Nordisk Company A/S
Papirfabrikken 74
DK-8600 Silkeborg
+45 7373 4000
info@nordisk.eu

SLOVAKIA

Prosport Praha s.r.o.
Ke Mlýnu 1
CZ-149 00 Praha 4 - Ujezd
+420 241 483 338
prosport@prosport.cz

SPAIN

GRANITEOUTDOOR
C/ Onze Setembre, 10, 08212,
Sant Llorenç Savall, Barcelona
+34 608 405 807
info@graniteoutdoor.net

THAILAND

Outdoor Heaven Co., Ltd
4392 Rama 4 Road Prakanong, Klongtoey
TH-Bangkok 10110
+66 (0) 81 817 2118
tatravee@thailandoutdoor.com



Nordisk Company A/S

Papirfabrikken 74 · DK-8600 Silkeborg
Tlf. +45 7373 4000 · info@nordisk.eu

Nordisk Freizeit GmbH

Max-Weber-Strasse 16 · DE-25451 Quickborn
Tel. +49 (0) 4106 76770 · info@nordisk.de

Nordisk Freizeit GmbH - Die Manufaktur

Rauschwalder Str. 42/43 · DE-02826 Görlitz
Tel. +49 3581 76560 · info@nordisk.de

Nordisk Asia Ltd.

Unit 904, Zhong Rong Heng Rui West Tower,
560 Zhang Yang Road · CN-200122 Shanghai
Phone +86 13901625206 · asia@nordisk.eu

Nordisk Japan Co., Ltd.

Greenland Aoyama Bldg. III 301, 6-6-22,
Minami-Aoyama, Minato-ku, Tokyo 107-0062, Japan
Tel. +81(0) 3 6885 8206 · info@nordisk.co.jp

www.nordisk.eu



nordiskoutdoor